



LEICA V-LUX 40

Instructions

Table of contents

Before use		Basics	
Before use	6	Sequence of operations	25
About GPS	8	Taking pictures with automatic exposure control [Program AE] mode	27
Scope of Delivery	9	Storing a focus setting	28
Accessories	9	Releasing the shutter by touch operation	29
Names and functions of the main components	10	Locking focus and exposure settings with touch operation	30
Cursor buttons	11	Taking pictures with [Snapshot Mode]	31
Touch operations	12	About flash	31
Preparations		Automatic Scene Detection	32
Charging the battery	13	About the Happy color setting	32
Inserting the battery	14	[Motion Deblur]	33
Charging the battery	15	[iHandheld Nite Shot]	33
Remaining battery capacity	16	[iHDR] (Intelligent High Dynamic Range)	34
Guidelines for the number of recordable pictures and operating time	17	AF Tracking	35
Inserting and removing the memory card	19	[Snapshot Mode] restrictions	36
Picture save destination (memory card / built-in memory)	20	Taking motion pictures	37
Displaying the picture recording capacity	21	Recording still pictures while a motion picture is being recorded	41
Recording capacity guidelines (pictures/recording time)	22	Viewing your pictures	42
Setting the clock	23	Viewing an enlarged section	43
Changing the time setting	24	Viewing several reduced pictures	43
		Viewing pictures by their recording date	44
		Viewing motion pictures	45
		Capturing still pictures from motion pictures	47
		[Video Divide]	48
		Deleting pictures	49
		Deleting multiple (up to 100)/ Deleting all pictures	50
		Setting the menu	51
		Menu types	52
		Using the Quick menu	53

Using the [Setup] menu	54
[Clock Set]	54
[Auto Clock Set]	54
[World Time]	54
[Travel Date]	54
[Beep]	54
[Volume]	55
[Cust.Set Mem.]	55
[LCD Display]	55
[LCD Mode]	55
[Guide Line]	56
[Histogram]	56
[Video Rec Area]	56
[Zoom Resume]	56
[Economy]	57
[Auto Review]	57
[No.Reset]	58
[Reset]	58
[USB Mode]	58
[Output]	59
[HDTV Link]	59
[3D Playback]	59
[Rotate Disp.]	60
[Version Disp.]	60
[Format]	60
[Language]	61
[O.I.S. Demo.]	61

Recording

Changing recording information display	62
Using the zoom	63
Zooming with touch operation	64
Zoom modes and their application	65
Taking pictures with flash	66
Taking close-up pictures	68
Focus range	68
[Macro Zoom]	69
Taking pictures with the self-timer	70
Taking pictures with Exposure Compensation	71
Taking picture series with automatically changed exposure	72
Using a pre-set aperture to determine the depth of field - [Aperture-Priority] Mode	73
Using a pre-set shutter speed to determine the rendition of moving subjects - [Shutter-Priority] Mode	74
Using a pre-set aperture/shutter speed combination to achieve full control of the exposure - [Manual Exposure] Mode	75
Taking Pictures with different picture effects [Creative Control] mode	76
Taking pictures with settings matched to the encountered scene [Scene Mode]	78
[Portrait]	79
[Soft Skin]	79
[Scenery]	79
[Panorama Shot]	79
[Sports]	81
[Night Portrait]	81
[Night Scenery]	81
[Handheld Night Shot]	81
[HDR]	82
[Food]	82
[Baby]	82
[Pet]	82
[Sunset]	83
[High Sens.]	83
[Through window]	83
[High Speed Video]	83

Taking 3D pictures	84
Registering your own setting combinations [Custom] Mode	85
[Cust.Set Mem.]	85
[Custom].....	86
Taking picture series	87
Taking pictures with the Face Recognition function	89
Registering faces	90
Editing or deleting information about registered persons	91
Useful features for travel	92
[Travel Date].....	92
[World Time].....	93
Entering Text	94
Using the [Rec] menu	95
[Aspect Ratio].....	95
[Picture Size].....	95
[Quality]	96
[Sensitivity].....	96
[White Balance].....	97
[AF Mode].....	99
[Quick AF].....	100
[Face Recog.].....	101
[Metering Mode]	101
[i.Exposure]	101
[Min. Shtr Speed]	102
[i.Resolution]	102
[Digital Zoom].....	102
[Burst].....	103
[Color Mode].....	103
[AF Assist Lamp].....	103
[Red-Eye Removal]	104
[Stabilizer]	104
[Date Stamp].....	105
[Clock Set].....	105
Using the [Motion Picture] menu	106
[Rec Mode].....	106
[Rec Quality].....	107
[Continuous AF].....	108
[Wind Cut]	108

Reviewing

Playing back still pictures recorded using the serial exposure function	109
Different playback methods	111
[2D/3D Settings].....	111
[Slide Show]	112
[Filtering Play]	114
[Calendar].....	114
Retouching pictures	115
[Auto Retouch]	115
[Creative Retouch]	116
Using the [Playback] menu	117
[Title Edit]	117
[Edit GPS Data].....	117
[Text Stamp]	118
[Resize]	120
[Cropping].....	121
[Favorite]	122
[Print Set]	123
[Protect].....	124
[Face Rec Edit].....	125
[Copy].....	126

GPS and map functions

Using the GPS function to record the picture taking location.....	127
Using the GPS function to execute positioning.....	128
Executing the positioning function immediately to update the current location...	131
Changing place name information to be displayed.....	133
Disabling the positioning function when the camera is turned off.....	134
Changing the place name information to be recorded.....	135
Changing the recorded GPS information.....	136
[Edit Location].....	136
[Edit Place Name].....	138
Adjusting the time using GPS.....	139
Reducing the time required for positioning.....	140
About the "GPS Assist Tool".....	140
Using the "GPS Assist Tool".....	141
Updating the GPS assist data.....	143
Checking the expiration date of the GPS assist data.....	144
Using the map function.....	145
Confirming the place where you took a picture using a map.....	145
Displaying your current location on a map.....	146
Displaying only pictures taken in the same area.....	147
Displaying a map by selecting a country or region.....	148
Using the map data on the DVD.....	149
Installing "LEICA Map Tool".....	149
Copying the map data to a memory card...	150
Registering my landmark.....	152
Registering my landmark from a map.....	152
Registering the recording location as my landmark.....	153
Selecting My landmark and displaying it on a map.....	154
Editing or deleting my registered landmark.....	154

Connecting with other devices

Playing back on a TV.....	155
HDTV Link (HDMI).....	157
Playing back 3D still pictures.....	159
Copying the recorded still and motion pictures.....	161
Copying by inserting the SD card into a recorder.....	161
Dubbing playback pictures with the AV cable.....	161
Copying the recorded image data to a computer with the supplied software.....	162
Using with your PC.....	163
Copying still and motion pictures recorded in [MP4] and [High Speed Video] Scene Mode (except AVCHD motion pictures).....	164
Printing.....	166
Printing multiple pictures.....	168
Printing with date and text.....	168
Making print settings on the camera.....	169

Miscellaneous

List of monitor displays.....	170
Message displays.....	174
Q&A Troubleshooting.....	176
Usage cautions and notes.....	184
Licence Agreement for Place Name and Map Data.....	188
Leica service addresses.....	195

Before use

■ Camera handling



Protect the camera against excessive vibration, force, or pressure.

● Avoid using the camera under the following conditions, which may damage the lens, LCD monitor, or camera body. This may also cause the camera to malfunction or prevent recording.

- Dropping or hitting the camera against a hard surface
- Sitting down with the camera in your pants pocket or forcing it into a full bag
- Attaching accessories to the wrist strap
- Exerting excessive force on the lens or monitor

The camera is not dust resistant, splash resistant, or waterproof.

Avoid using the camera in places with excessive dust or sand, or where it can come into contact with water.

● Avoid using the camera under the following conditions, which present a risk that sand, water, or foreign material may enter the camera through the gaps around the lens or buttons. Be especially careful because these conditions may damage the camera, and such damage may not be repairable.

- In extremely dusty or sandy places
- In the rain or by the shore, where the camera may be exposed to water

■ Condensation (When the lens or the monitor is fogged up)

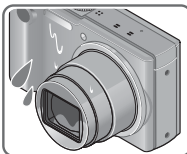

- Condensation may occur when the camera is exposed to sudden changes of temperature or humidity. Avoid these conditions, which may temporarily fog up, the lens or the monitor, cause mold, or damage the camera.
- If condensation does occur, turn off the camera and wait about two hours before using it. Once the camera takes on the surrounding temperature, the fogging will disappear by itself.

Always take a test shot first

Before important events when you intend to use the camera (at weddings, for example), always take a test shot to make sure that pictures and sound record correctly.

No compensation for missed shots

Leica Camera AG cannot compensate for missed shots if technical problems with the camera or card prevent recording.

Carefully observe copyright laws

Unauthorized use of recordings which contain works with copyright for purposes other than personal use is prohibited under copyright law. Recording of certain material may be restricted even for the purpose of personal use.

Also refer to “Usage cautions and notes” (→184)

- Please note that the actual controls and components, menu items, and other information for your camera may differ from those in the illustrations and screens provided in these instructions.

- Recording mode icons

Modes: **A P A S M** C1 C2 3D SCN 

Available

Unavailable

About GPS

■ About the camera's location name information

Before using the camera, be sure to read "Licence Agreement for Place Name and Map Data". (→188)

■ When [GPS Setting] is [ON], the GPS function works even if the camera is turned OFF.

- Electromagnetic radiation from the camera can affect instruments and meters. During takeoff and landing of airplanes or in other restricted areas, set [GPS Setting] to [OFF] or set [Airplane Mode] to [ON], and then turn off the camera. (→128, 134)
- When [GPS Setting] is [ON] and [Airplane Mode] is [OFF], power will drain from the battery even if the camera is turned OFF.

■ Recording location information

- The names of recording locations and landmarks (such as buildings) are current as of December 2011. These will not be updated.
- Depending on the country or area, limited location name and landmark information may be available.

■ Positioning

- Positioning will take time in environments where it is difficult to receive the signals from the GPS satellites. (→127)
- **Even if GPS reception is good, it will take approx. 2 to 3 minutes to successfully execute positioning under the following conditions: when positioning is executed for the first time, or when positioning is executed after the camera is turned off with the [GPS Setting] set to [OFF] or [Airplane Mode] set to [ON], and then turned on again.**
Positioning can be executed faster using GPS assist data. (→140)
- Because the GPS satellite positions are constantly changing, depending on the recording location and conditions, contact to some satellites may not be possible, resulting in inaccurate positioning data.

■ When using in another country

- GPS may not work in China or in the border regions of countries neighboring China. (Current as of December 2011)
- Some countries or regions regulate the use of GPS or related technology. Because this camera has a GPS function, before taking it into another country, check with the embassy or your travel agency whether there are any restrictions on bringing cameras with a GPS function.

Scope of Delivery

	Order No.
Rechargeable battery	
BP-DC7-E	18 701
BP-DC7-U	18 702
Charger	
ACA-DC11-U	423-106.001-003
ACA-DC11-K	423-106.001-004
ACA-DC11-E	423-106.001-005
ACA-DC11-B	423-106.001-006
ACA-DC11-A	423-106.001-007
ACA-DC11-C	423-106.001-008 (delivery differs depending on markets)
Wrist strap	423-068.801-015
CD-ROM with instr.-PDFs	423-106.001-023
DVD with Adobe® Photoshop® Elements®	423-106.001-021
DVD with Adobe® Premiere® Elements®	423-106.001-022
DVD with LEICA Map Tool	423-106.001-020
USB cable	423-105.001-010
AV cable	423-106.001-009
Button template for Canada / Taiwan	423-083.001-026 / -027
Short instructions	93 433 - 93 436 (delivery differs depending on markets)
Warranty Card	439-399.100-026

Accessories

	Order No.
Leather case	18 751
HDMI mini cable	14 491
Mini tripod	14 320
Tabletop tripod	14 100
Ball and Socket head	14 110

Notes:

- In these instructions, the unit labeled “AC adaptor” is referred to as charger.
- Cards are optional. You can record or play back pictures on the built-in memory when you are not using a card.
- Check that all items belonging to the scope of delivery are included before using the camera.
- The items and their shape may differ depending on the country or area where the camera was purchased.
- Please dispose of all packaging appropriately.
- Keep small parts in a safe place out of the reach of children.

Names and functions of the main components

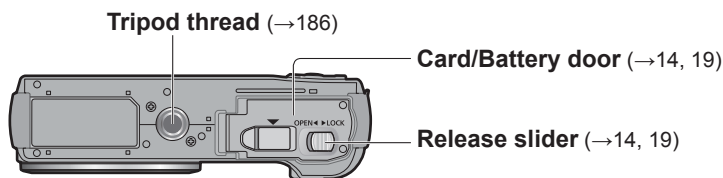
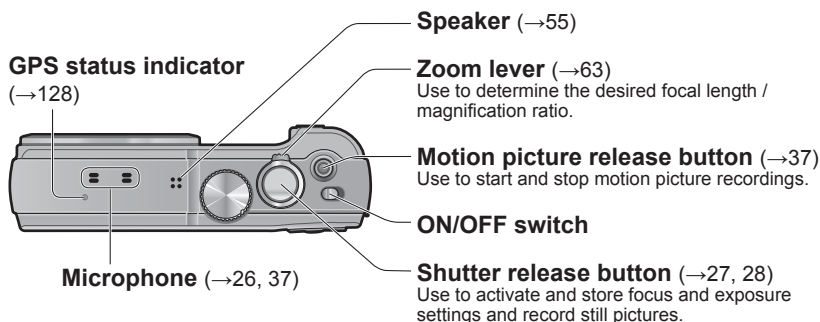
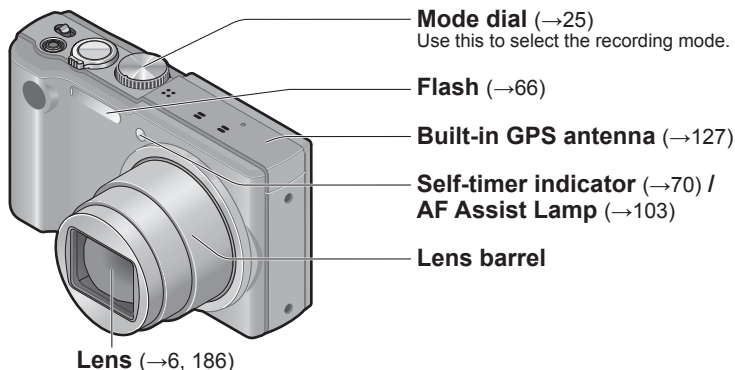

● The illustrations in these instructions may differ from the actual product.

Names and functions of the main components

LCD monitor
(→55, 62, 170)

REC/PLAY switch (→25)
Use to select the recording or playback mode.



We recommend using the supplied wrist strap to avoid dropping the camera.

[EXPOSURE] / [MAP] button (→73, 145)
In recording mode: Use to set shutter speed or aperture values. (Only in the **A**, **S**, **M** modes)
In playback mode: Use to display a map.

[DISP.] button
(→62)
Use to switch displays.

Charging lamp
(→16)

[Q.MENU] / [] / [] button
In recording mode: Quick menu is displayed. (→53)
In playback mode: Pictures are deleted. (→49)
During menu operations: Use to recall the previous screen.

[HDMI] socket
(→155, 157)



[AV OUT/DIGITAL] socket
(→15, 155, 164, 166)

Cursor buttons

[MENU/SET]
• Use to display the menus, enter the settings, etc. (→51)

Left cursor button (◀)
• Self-timer (→70)

Down cursor button (▼)
• Macro Mode etc. (→68)

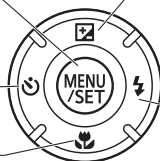

Up cursor button (▲)
• Exposure Compensation, Auto Bracketing etc. (→71, 72)

Right cursor button (▶)
• Flash (→66)

● In these instructions, the button to be used is indicated by ▲ ▼ ▶ ▶.

Touch operations

This camera's monitor surface senses pressure that is applied to it.

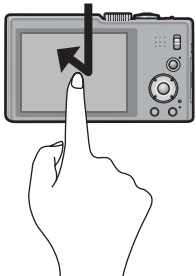
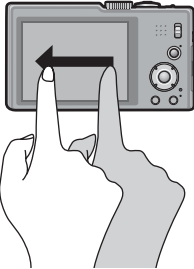
<p>Touch</p> <p>To "touch" is to press the monitor's surface and then pull the finger back again.</p>	<p>Drag</p> <p>To "drag" is to touch and slide your finger across the monitor's surface.</p>
 <p>Touching is used to select icons or pictures, among other actions.</p> <ul style="list-style-type: none"> • Touch an icon near its center. If multiple icons are touched simultaneously, the camera may not operate normally. 	 <p>Dragging (sliding your finger across the monitor's surface) is used to scroll the pictures or to scroll to the next group of pictures.</p>

- If you want to use one of the protective foils available on the market on the monitor, observe the precautions that are contained with the foil. (Some types of protective foils may impair the monitor image's appearance and ease of operation.)
- If the camera is used with a such a foil resulting in the monitor not being very responsive, apply a little more pressure.
- If you apply pressure to the monitor's surface with your hand when holding the camera, it will not work properly.
- Do not use objects with hard pointed tips (such as ball point pens or your fingernails).
- Clean the monitor with a soft, dry cloth if there are fingerprints or other kinds of dirt on it.
- For details of the icons that appear during touch operations, refer to "List of monitor displays" (→170).

Charging the battery

- Always use the dedicated charger, USB connection cable, and battery for this camera.

Always charge before first use! (the battery is shipped uncharged)

- The battery is charged while it is in the camera.

Camera status	Charge
Turned off (also in [Sleep Mode] (→57))	Yes
Turned on	No*

* During playback only, the camera operates using power supplied from the mains through the USB connection cable. (The battery is not charged.)

- When the battery does not have sufficient remaining power, charging may be done regardless of the camera ON/OFF switch setting.
- If the battery is not inserted, neither charging nor power supplying is possible.

■ About batteries that you can use with this camera

It has been found that counterfeit batteries which look very similar to the genuine products are available in some markets. Some of these batteries are not adequately protected with internal protection to meet the requirements of appropriate safety standards. There is a possibility that these batteries may lead to fire or explosion. Please be advised that Leica Camera AG is not liable for any accident or failure occurring as a result of use of a counterfeit battery. To ensure that the batteries used are safe, we urgently recommend to use only the dedicated Leica battery BP-DC7 (→9).

Inserting the battery

To charge the battery, insert it into the camera.

- Set the camera ON/OFF switch to OFF

- 1 Push to the release slider to the [OPEN] position and open the card/battery door**

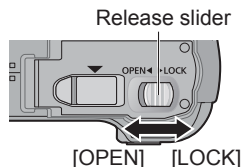

- 2 Completely insert the battery**
 - Make sure it is aligned correctly and push it in until it is locked by the gray lever.

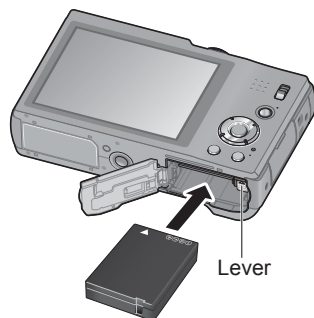

- 3 Close the card/battery door**
 - Push the release slider to the [LOCK] position.

■ To remove the battery

Move the lever in the card/battery compartment in the direction of the arrow.

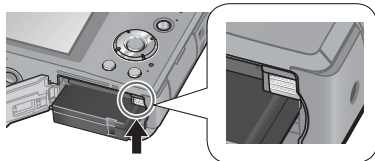

- Always use a genuine Leica BP-DC7 battery (→9).
- Leica Camera AG cannot guarantee the quality of other batteries.
- **Remove the battery if you are not going to use the camera for a long time.**
 - Store batteries e.g. in a case so that their terminals cannot be shorted by metallic objects.
- To remove the battery, turn the camera off and wait until the LEICA indicator on the monitor goes off. (Failing to wait may cause the camera to malfunction and may damage the card or recorded data.)

Charging the battery

We recommend charging in a location where the ambient temperature is between 10°C and 30°C (50°F to 86°F) (same for the battery temperature).

Set the camera ON/OFF switch to OFF

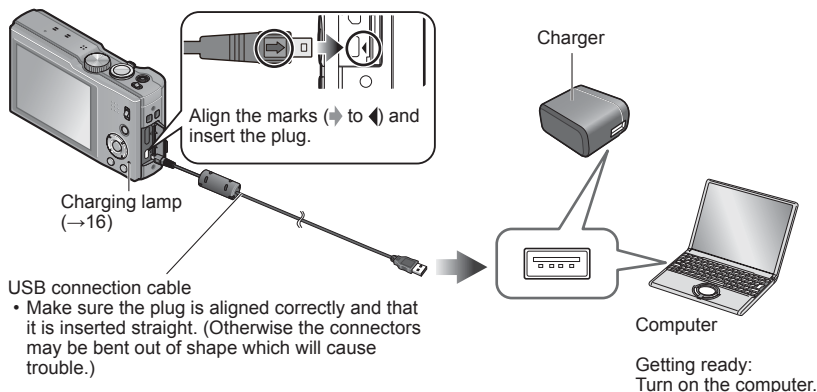

■ Charging the battery by connecting the camera to the electrical outlet

Connect the camera and the charger using the USB connection cable, and plug the latter into a mains outlet.

- Charging should only be performed indoors.

■ Charging the battery through a computer

Connect a computer to the camera using the USB connection cable.

- It may not be possible to charge the battery from some computers depending on the computer specifications.
- If the computer enters hibernation mode during charging, charging may be stopped.
- If the camera is charged from a notebook that is not connected to a mains outlet, the notebook's battery will be depleted. Do not leave the camera and notebook connected for a long period of time.
- Always connect the USB cable to a USB port on your computer. Do not connect it to a USB port of a monitor, keyboard, printer, or USB hub.

■ Charging lamp indications

On: Charging in progress

Off: Charging is completed (After charging stops, disconnect the camera from the mains outlet or your computer.)

■ Notes on charging time

Charging time	Approx. 260 min
----------------------	-----------------

- The charging time indicated above is the time required for charging when the battery is completely depleted. The time required for charging differs depending on conditions of battery usage. Charging takes longer when temperatures are either high or low and when the battery has not been used for a long period of time.
- The time required for charging through the computer varies depending on the specifications of the computer.
- Do not use any other USB connection cables except the supplied one. Doing so may cause malfunction of the camera.
- Do not use a USB extension cable.
- The supplied charger and USB connection cable are dedicated accessories of this camera. Do not use it for other devices.
- If there is any trouble related to the mains outlet (i.e. power failure), charging may not be completed properly. Disconnect the USB connection cable and reconnect it to the camera.
- If the charging lamp does not light or flash even when the camera is properly connected to the charger or your computer, the process has been put in pause status because the temperature is not in the appropriate range for charging. This is not a malfunction. Reconnect the USB connection cable and retry charging in a place where ambient temperature is 10°C and 30°C (50°F to 86°F) (temperature conditions also apply to the battery itself).

Remaining battery capacity



Remaining battery



If the battery mark flashes red, recharge or replace the battery.

Guidelines for the number of recordable pictures and operating time

The number of recordable pictures or available operating time may vary according to surrounding environment and usage conditions. Figures may be reduced if flash, zoom, or other functions are used frequently, or in colder climates.

■ Recording still pictures

Number of recordable pictures	Approx. 260	By CIPA standard
Recording time	Approx. 130 min	

● Recording conditions by CIPA standard

- CIPA is an abbreviation of [Camera & Imaging Products Association].
- [Program AE] Mode
- [GPS Setting] is set to [OFF]
- Temperature: 23°C (73.4°F)/Humidity: 50%RH when LCD monitor is on.
- Using a 32 MB memory card.
- Using the supplied battery.
- Starting recording 30 seconds after the camera is turned on. (When the Optical Image Stabilizer function is set to [ON].)
- Recording once every 30 seconds with full flash every second recording.
- Zooming from Tele to Wide or vice versa for every recording.
- Turning the camera off every 10 recordings and leaving it until the temperature of the battery decreases.

The number is reduced if intervals are longer (e.g. to approx. one quarter for 2-minute intervals under the above conditions).

■ Recording motion pictures

[Rec Mode]	[AVCHD]		[MP4]
[Rec Quality]	[GPH] [PSH]	[GFS] [FSH]	[FHD]
Available recording time* ¹	Approx. 55 min	Approx. 65 min	Approx. 70 min
Actual available recording time* ²	Approx. 30 min	Approx. 35 min	Approx. 40 min

● Recording conditions

- Temperature is 23°C (73.4°F), humidity 50%RH
- [GPS Setting] is set to [OFF]

*¹ With camera models 18 176 / 18 177

If [Rec Quality] of [AVCHD] motion pictures is set to [GPH], [PSH], [GFS] or [FSH], you can continuously record a motion picture for up to 29 minutes. (→107)

You can continuously record a motion picture in [MP4] for up to 29 minutes or approx. 4 GB.

(In this case, you can continuously record a motion picture in [FHD] for up to approx. 27 minutes 12 seconds.) The remaining time for continuous recording is displayed on the screen.

With camera model 18 175

Motion pictures can be recorded continuously for up to 29 minutes. Also, motion picture recorded continuously in [MP4] is up to 4 GB. (In this case, you can continuously record a motion picture in [FHD] for up to approx. 27 minutes 12 seconds.) The remaining time for continuous recording is displayed on the screen.

*² The time you can actually record when repeatedly turning the power on and off, starting and stopping recording and using zoom.

■ Viewing pictures

Playback time	Approx. 160 min
---------------	-----------------

Inserting and removing the memory card

- Set the camera ON/OFF switch to OFF

- 1 Push to the release slider to the [OPEN] position and open the card/battery door**

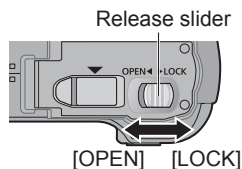

- 2 Insert the card all the way**

- Push it in until it clicks.

- 3 Close the card/battery door**

- Push the release slider to the [LOCK] position.

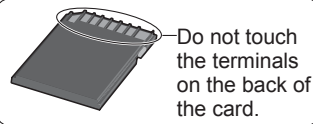
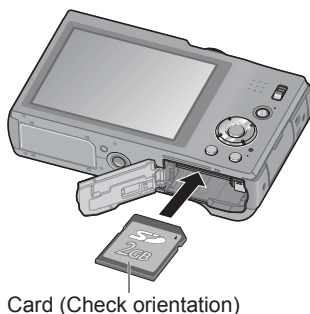

■ To remove the card

Push it further down until it clicks, then pull it straight out.

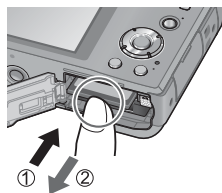

- Keep the Memory Card out of reach of children to prevent swallowing.
- To remove the card, turn the camera off and wait until the LEICA indicator on the monitor goes off. (Failure to wait may cause the camera to malfunction and may damage the card or recorded data.)

Picture save destination (memory card / built-in memory)

Pictures will be saved to a card if one is inserted, or to the built-in memory  if not.

■ Built-in memory (approx. 12 MB)

- You can store only still pictures.
- **Pictures may be copied between cards and the built-in memory. (→126)**
- The access time for the built-in memory may be longer than the access time for a card.

■ Compatible memory cards

The following SD standard-based cards

Type of Card	Capacity	Notes
SD Memory Cards	8 MB – 2 GB	<ul style="list-style-type: none">• Using a card of SD speed “Class 4”* or above is recommended for recording motion pictures.• The cards can be used with devices compatible with the respective formats.• Before using SDXC cards, check that your computer and other devices support this type of card.• Only the cards listed on the left with the given capacities are supported.
SDHC Memory Cards	4 GB – 32 GB	
SDXC Memory Cards	48 GB, 64 GB	

* SD speed class refers to a specification for sustained write speeds. Confirm the SD speed by checking the card label or other card related materials.

(Example)



- Please reformat the card with this camera if it has already been formatted with a computer or another device. (→60)
- If the write-protect switch is set to “LOCK”, the card cannot be used to record or delete pictures, and it cannot be formatted.
- It is recommended that you copy important pictures to your computer (as electromagnetic radiation, static electricity, or faults may cause data to be damaged).



Switch

Displaying the picture recording capacity



Estimated remaining pictures or recording time capacity
(press [DISP.] button to switch display)

Displayed when no card is inserted
(pictures will be saved to built-in memory)

While the camera is accessing the card or the built-in memory (for an operation such as picture writing, reading, deletion, or formatting), do not turn off the camera or remove the battery, the card, or disconnect the charger. Do not subject the camera to vibrations, impact, or static electricity.



The card or the data on the card may be damaged, and the camera may no longer operate normally.

If an operation fails due to vibration, impact or static electricity, perform it again.

Recording capacity guidelines (pictures/recording time)

The number of pictures you can take and the recording time vary in proportion to card capacity (and depending on recording conditions and type of card).

■ Recording picture capacity (still pictures)

[Picture Size]	Built-in memory	2 GB	32 GB	64 GB
4:3  14 M	1	330	5490	10980
4:3  5 M	3	650	10620	21490
4:3  0.3 M	67	10050	162960	247150

- When the number of recordable pictures exceeds 99,999, "+99999" is displayed.

■ Recording time capacity (motion pictures)

([h], [m] and [s] indicate "hour", "minute" and "second".)

When the [AVCHD] recording mode is used

[Rec Quality]	Built-in memory	2 GB	32 GB	64 GB
[GPH] [PSH]	–	8 m 00 s	2 h 31 m 00 s	5 h 07 m 00 s
[FSH] [SH] [GFS] [GS]	–	14 m 00 s	4 h 10 m 00 s	8 h 26 m 00 s

• With camera models 18 176 / 18 177

If [Rec Quality] of [AVCHD] motion pictures is set to [GPH], [PSH], [GFS] or [FSH], you can continuously record a motion picture for up to 29 minutes (→107). Remaining time for continuous recording is displayed on the screen.

When the [MP4] recording mode is used

[Rec Quality]	Built-in memory	2 GB	32 GB	64 GB
[FHD]	–	12 m 07 s	3 h 23 m 02 s	6 h 51 m 01 s
[HD]	–	23 m 08 s	6 h 27 m 38 s	13 h 04 m 41 s
[VGA]	–	50 m 56 s	14 h 13 m 08 s	28 h 46 m 57 s

• With camera models 18 176 / 18 177

You can continuously record a motion picture in [MP4] for up to 29 minutes or approx. 4 GB. (In this case, you can continuously record a motion picture in [FHD] for up to approx. 27 minutes 12 seconds.) The remaining time for continuous recording is displayed on the screen.

• With camera model 18 175

Motion pictures can be recorded continuously for up to 29 minutes.

A single [MP4]-format motion picture take can be recorded up to a maximum file size of 4 GB. (In this case, you can continuously record a motion picture in [FHD] for up to approx. 27 minutes 12 seconds.) The remaining time for continuous recording is displayed on the screen.

- When map data is copied to a memory card, the number of recordable pictures and recording time will decrease. (→149)

Setting the clock

The clock is not set when the camera is shipped.
Set the REC/PLAY switch to  before turning on the power.

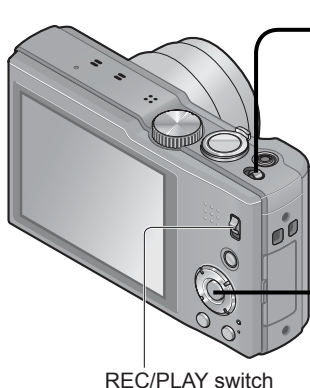

1 Turn on the power



2 Press [MENU/SET] while the message is displayed

3 Press ▲ ▼ to select the language, and then [MENU/SET]

4 The [Please set the clock] message appears. Press [MENU/SET]

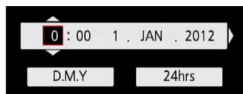

5 Press ◀ ▶ to select the items (year, month, day, hour, minute, display order or time display format), and then ▲ ▼ to set



• To cancel → Press the  /  button.

6 Press [MENU/SET] to set

7 Press [MENU/SET]

• To return to the previous screen, press the  /  button.

(Continued on the next page)

8 Press ◀ to select [Yes] and then [MENU/SET] if you want the time to be corrected automatically by the GPS function

- To manually set date and time → select [No].
- When you select automatic time adjustment using the GPS function, [GPS Setting] is set to [ON].

9 When [Please set the home area] is displayed, press [MENU/SET]

10 Press ◀▶ to set your home area and then [MENU/SET]

City or area name Current time



↳ Difference from GMT (Greenwich Mean Time)

Changing the time setting

When resetting date and time, select [Clock Set] from the [Setup] or [Rec] menu.

- Clock settings will be saved for approx. 3 months even after the battery is removed, provided it was fully-charged and installed in the camera for 24 hours beforehand.

1 Select [Clock Set] from the [Setup] or [Rec] menu

- For details about the setting procedure in the [Setup] menu (→51)

2 Set the date and time (Perform steps 5 - 6. (→23))

- If the clock is not set, the correct date cannot be printed when you order a shop to print the picture, or when you stamp the date on the pictures with [Date Stamp] or [Text Stamp].
- If the clock is set, the correct date can be printed even if the date is not displayed on the screen.

Sequence of operations

1

Turn on the power



2

Set to 

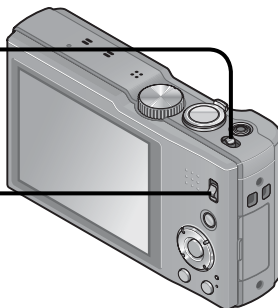

3 Set to the desired recording mode

Align the desired mode on the dial exactly opposite the index mark. →

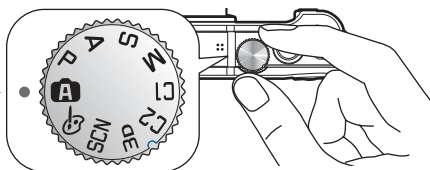

3

A	[Snapshot Mode]	For taking pictures with snapshot mode (with extended automatic settings). (→31)
P	[Program AE] Mode	For taking pictures with automatic exposure control. (→27)
A	[Aperture-Priority] Mode	The exposure is determined by the automatically controlled shutter speed, based on the manually set aperture value. (→73)
S	[Shutter-Priority] Mode	The exposure is determined by the automatically controlled aperture value, based on the manually set shutter speed. (→74)
M	[Manual Exposure] Mode	The exposure is determined by the manually set aperture value and shutter speed. (→75)
C1 C2	[Custom] Mode	For taking pictures with previously registered settings. (→85)
3D	[3D Photo Mode]	For taking 3D still pictures. (→84)
SCN	[Scene Mode]	For taking pictures with factory-registered settings matching the scene being recorded. (→78)
	[Creative Control] Mode	For taking pictures with pre-selected effects. (→76)

Aim the camera and shoot

■ To take still pictures

- ① Press the shutter release button halfway to focus
- ② Press and hold the button to take the picture

■ To record motion pictures

- ① Press the motion picture release button to start recording
- ② Press the button again to finish recording

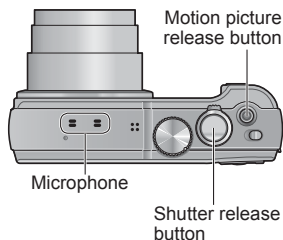

4 ■ How to hold the camera

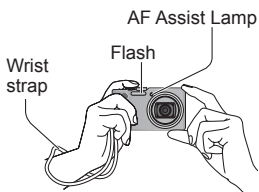

- To avoid camera shake, hold it with both hands keeping your arms close to your body while standing with your feet slightly apart.
- Do not touch the lens barrel.
- Do not cover the microphone when recording motion pictures.
- Do not cover the flash or the lamp. Do not look at the flash from close range.
- Make sure that the camera does not move at the moment the shutter release is pressed.

- We recommend using the supplied wrist strap to avoid dropping the camera.

5 Set to



6 To view pictures (→42, 45)



- Press ◀▶ to select a picture
- Press ▲ to play back motion pictures or panorama pictures

7 To turn off the power



Taking pictures with automatic exposure control

[Program AE] mode

Recording mode: A S M C1 C2 3D SCN

Use the [Rec] menu to change settings and set up your own recording environment.

- Slide the REC/PLAY switch to

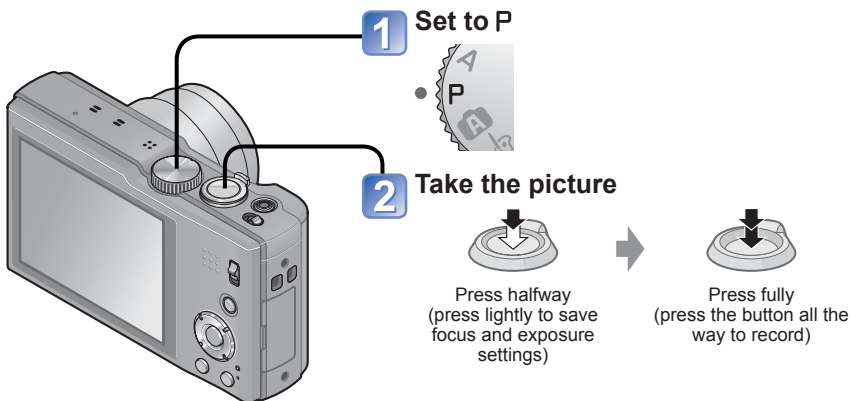

- If the camera-shake warning is displayed, use [Stabilizer], a tripod, or [Selftimer].
- If the aperture and shutter speed appear in red, this usually indicates underexposure. In such cases you should either use the flash, change the [Sensitivity] settings or set [Min. Shtr Speed] to a slower speed.

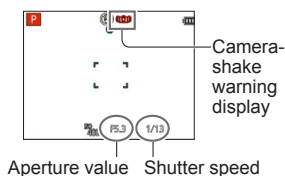

Storing a focus setting

When [AF Mode] is set to  (1-area-focusing), the camera focuses on the objects detected in the area defined by the AF marks in the center of the screen. If you wish to place a correctly focused subject off-center, follow the steps below.

1 Focus on the desired subject

Aim the AF-area at the subject



Press halfway and hold



Focus display

(When focusing is successful: illuminated
When focusing is not possible: flashing)

AF area frame

(When focusing is successful: green
When focusing is not possible: red)

2 Determine the desired composition



Press fully



AF area

- Subjects/environments which may make focusing difficult:
 - Fast-moving or extremely bright objects, or objects without color contrast.
 - When taking pictures through glass or near objects emitting light. In dark areas, or with considerable camera shake.
 - When an object is too close or when there are both distant and close objects within the AF area.

- The focus display flashes and beep sounds when focusing is not successful.

Use the focus range displayed in red as a reference.

Even if the focus display is lit, the camera may be unable to bring the subject into focus if it is out of range.

- The AF area display may be larger depending on recording conditions such as dark locations or zoom ratio.

Focus display

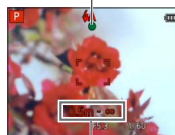

Focus range

Releasing the shutter by touch operation

(Touch Shutter function)

This function enables you to focus on the desired subject and release the shutter simply by touching the respective subject on the screen.

1 Touch on the screen



- The icon changes to , and you can now proceed with touch shutter release operation.

2 Touch the subject you want to have focused

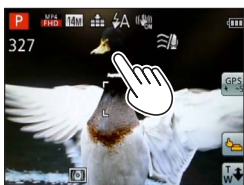

- The subject you touched is focused.
- To release the shutter → Touch .

- This function is not available for motion pictures.
- This function does not work for subjects at the edges of the screen.
- Please note that the shutter will be released even if you inadvertently touch the screen.
- The setting of this function will be stored even if the camera is turned off.

Locking focus and exposure settings with touch operation



(Touch AF/AE function)

This function enables you activate the focus and exposure settings by touching the desired subject on the screen.

- Perform these operations with the touch shutter function (→29) deactivated.

1 Touch the desired subject on which the focus and exposure settings should be based



- When [AF Mode] is set to  (Face Detection), the Face Detection function continues to operate, but the focus is adjusted to the subject you touched.
- When [AF Mode] is set to , the camera locks onto the subject, automatically continues to focus on it and adjusts the exposure as it moves.

2 Press the shutter release button halfway to bring the subject into focus, and then fully to record the subject

- To deactivate the touch AF/AE function → Touch .

- This function may fail to work under some recording conditions such as when the subject is too small or the recording location is too dark.
- This function does not work for subject at the edges of the screen.
- During [Snapshot Mode], the camera will determine the optimal scene mode based on the touched subject.

Taking pictures with [Snapshot Mode]

Recording mode: **A** P A S M C1 C2 3D SCN

Optimum settings are made automatically by the camera based on information such as "face", "movement", "brightness", and "distance" just by pointing the camera at the subject. This results in sharp and well-exposed pictures without the need to make settings manually.

- Slide the REC/PLAY switch to .

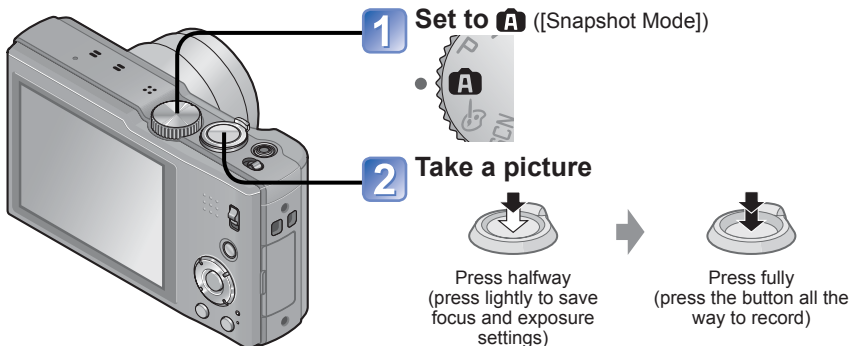

Focus display

(When focusing is successful: illuminated
When focusing is not possible: flashing)



About flash

Press to select or .

- When is selected, the best flash mode is selected automatically depending on conditions (, , ,).
- When or is selected, the red-eye reduction function is activated.
- When or is selected, slower shutter speeds can be used.

Automatic Scene Detection

The camera recognizes many scene types based on the captured subjects, and makes optimum settings automatically.



The icon of the determined scene mode

	A person was recognized
	A baby was recognized* ¹
	A landscape was recognized
	A night scene with persons was recognized (Only when [iA] is selected)* ²
	A night scene was recognized* ²
	A night scene and considerable camera movement was recognized* ³
	A nearby subject was recognized
	A sunset was recognized
	Reads subject movement to avoid blurring when the scene does not correspond to any of the above.

*¹ When babies (under 3 years) registered with the Face Recognition function are recognized

*² We recommend using a tripod and the self-timer.

*³ When [iHandheld Nite Shot] is [ON]

- Depending on recording conditions, different scene types may be determined for the same subject.
- If the desired scene type is not selected, we recommend manually selecting the appropriate scene mode.
- When or is set, Face Detection is activated, and the focus and exposure are based on recognized faces.
- About Backlight Compensation

Backlight is a condition where the decisive part of the subject is considerably darker than the rest, resulting in underexposure of that part. Backlight compensation is automatically activated in [Snapshot Mode], it corrects the exposure by increasing the brightness of the entire image. When the camera detects backlight, is displayed on the monitor. The displayed icon () may not correspond to the actual backlight condition in some cases.

About the Happy color setting

When [Color Mode] is set to [Happy], pictures are recorded with vivid coloring.

■ Settings

- ① Press [MENU/SET]
- ② Use the respective cursor buttons to select [Rec] menu and press [MENU/SET]
- ③ Use the respective cursor buttons to select [Color Mode] and press [MENU/SET]
- ④ Use the respective cursor buttons to select [Happy] and press [MENU/SET]

[Motion Deblur]

The camera automatically sets the optimum shutter speed in accordance with the movements of the subject to minimize the blur of the subject.

■ Settings

- ① Press [MENU/SET]
 - ② Use the respective cursor buttons to select [Rec] menu and press [MENU/SET]
 - ③ Use the respective cursor buttons to select [Motion Deblur] and press [MENU/SET]
 - ④ Use the respective cursor buttons to select [ON] and press [MENU/SET]
- When [Motion Deblur] is set to [ON],  appears on the screen.
 - The subject may be recorded with a lower resolution than the one that is set.

[iHandheld Nite Shot]

Night scenes with handheld camera are detected automatically. A picture with less noise and camera shake is produced by combining a series of exposures.

■ Settings

- ① Press [MENU/SET]
 - ② Use the respective cursor buttons to select [Rec] menu and press [MENU/SET]
 - ③ Use the respective cursor buttons to select [iHandheld Nite Shot] and press [MENU/SET]
 - ④ Use the respective cursor buttons to select [ON] and press [MENU/SET]
- When the camera is fixed in place on a tripod or by other means, [iHandheld Nite Shot] will not be activated.

[iHDR] (intelligent High Dynamic Range)

When [iHDR] is set to [ON], the camera creates a single properly exposed picture with rich gradation by combining the image data of several differently exposed shots.

■ Settings

- ① Press [MENU/SET]
 - ② Use the respective cursor buttons to select [Rec] menu and press [MENU/SET]
 - ③ Use the respective cursor buttons to select [iHDR] and press [MENU/SET]
 - ④ Use the respective cursor buttons to select [ON] and press [MENU/SET]
- This function is automatically activated only when * is displayed on the monitor.
* This icon is displayed when the camera detects a backlight situation.
 - The camera does not combine pictures in the following cases:
 - When the zoom ratio exceeds 20 times
 - When [Burst] mode is used
 - Even when [iHDR] is set to [OFF], if the camera detects backlight, backlight compensation is activated automatically and the camera corrects the exposure by increasing the brightness of the entire image.
 - A subject that was in motion when it was recorded may be rendered as a double/multiple exposure.

AF Tracking

This function enables the camera to adjust both the focus and exposure settings continuously for a predetermined moving subject.

■With touch screen operations

Perform these operations with the touch shutter function (→29) deactivated.

1 Touch the subject

- When switching to lock on to another subject → Touch the other subject.
- To deactivate AF tracking → Touch .

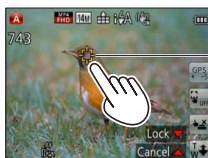

AF Tracking frame
AF Lock successful: Yellow
AF Lock failed: Red

■With cursor button operations

1 Press ▲ to set [AF Mode] to AF Tracking

- To cancel AF Tracking → Press ▲ again.

2 Aim the AF Tracking frame at the subject, and then press ▼ to lock

- To cancel AF Lock → Press ▼.



AF Tracking frame
AF Lock successful: Yellow
AF Lock failed: Red

- The optimal scene mode for the AF locked subject is automatically identified.
- Face Recognition will be inactive while using AF Tracking.
- Under certain recording conditions, such as when the subject is small or when it is dark, [AF Tracking] may not operate correctly.

[Snapshot Mode] restrictions

Only the menu items which are displayed in the [Snapshot Mode] can be set.





The settings selected in the [Program AE] or other modes will reflect on the menu items in the [Setup] menu that are not displayed.

- The settings for the following items are different from other recording modes:
[Picture Size], [Burst] and [Color Mode] on the [Rec] menu, and [Beep] on the [Setup] menu
- The settings for the following functions are fixed:

[Setup] menu

- [Auto Review]: [2SEC]
- [Guide Line]: 
- [Sleep Mode]: [5MIN.]

[Rec] menu

- [Quality]:  [Fine]
- [Stabilizer]: [ON]
- [AF Assist Lamp]: [ON]
- [Metering Mode]:  [Multi Metering]
- [i.Resolution]: [i.ZOOM]
- [White Balance]: [AWB]
- [Sensitivity]:  ISO
- [AF Mode]:  [Face Detection]*
- [Quick AF]: [ON]
- [i.Exposure]: [STANDARD]
- [Red-Eye Removal]: [ON]

*  (23-area-focusing) when face cannot be recognized

[Motion Picture] menu

- [Continuous AF]: [ON]
- [Wind Cut]: [AUTO]

- The following functions cannot be used:
[Histogram], [Exposure], [Auto Bracket], [WB Adjust.], [Min. Shtr Speed], [Digital Zoom]

Taking motion pictures

Recording modes: **A P A S M C1 C2 3D SCN** 

You can record motion pictures with audio (stereo).

- Slide the REC/PLAY switch to .
- Motion pictures cannot be recorded in the built-in memory.

Do not cover the microphone when recording motion pictures.

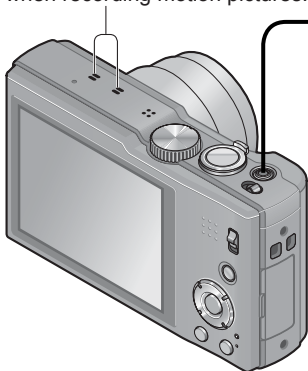

1 Press the motion picture release button to start recording

[Rec Mode] (→106)/[Rec Quality] (→107)

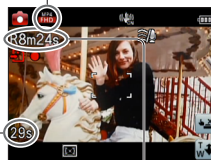

Elapsed recording time

Remaining recording time (approx.)

- Immediately release the button after pressing it.
- You can also use zoom while recording motion pictures.
 - The zoom speed will be slower than normal.
 - When using zoom while recording motion pictures, it may take some time to focus.
- Still pictures can be taken during motion picture recording. (→41)

2 Press the motion picture release button again to end recording

■ About the recording format for recording motion pictures

This camera can record motion pictures in either AVCHD or MP4 formats.

AVCHD:

This format allows recording high definition quality images. It is suitable for viewing on a large format TV or for saving to disc.

AVCHD Progressive:**With camera models 18 176 / 18 177**

[GPH] or [PSH] in [AVCHD] is a mode that allows motion pictures to be recorded at 1920 x 1080/60p, the highest quality* that complies with the AVCHD standard.

With camera model 18 175

[GPH] or [PSH] in [AVCHD] is a mode that allows motion pictures to be recorded at 1920 x 1080/50p, the highest quality* that complies with the AVCHD standard.

Recorded motion pictures can be saved and played back in this camera or using the supplied software.

* This means the highest quality for this camera.

MP4:

This is a simpler video format best used when extensive editing is needed, or when uploading videos to the Internet.

■ About the compatibility of the recorded motion pictures

Motion pictures recorded in [AVCHD] or [MP4] may be played back with poor picture or sound quality or playback may not be possible even when played back with equipment compatible with these formats. Also, the recording information may not be displayed properly. In this case, use this camera.

- Motion pictures recorded with [GPH] or [PSH] in [AVCHD] can be played back on equipment that is compatible with AVCHD Progressive.





■ Recording motion pictures in P



Records a motion picture at your preferred settings.

- Aperture and shutter speed are automatically set.

■ Recording motion pictures in A

The camera automatically determines the scene mode to record motion pictures with optimal settings.

A When scene does not correspond to any on the right.		
		

- In  mode, focus and exposure will be set according to the face detected.
-  will be selected for nightscapes and other dark scenes.
- If the camera does not select your desired Scene Mode, choosing an appropriate mode manually is recommended.
- The following menu options in the [Motion Picture] menu can be set:
 - [Rec Mode] • [Rec Quality]

■ Motion picture recording in other recording modes

For details, refer to the pages relating to the respective recording modes. (However, a motion picture cannot be recorded in [Panorama Shot] Scene Mode.)

- If the surrounding temperature is high, or a motion picture is recorded continuously,  is displayed and recording may be stopped halfway through to protect the camera. (Only when [Rec Quality] is set to [GPH], [PSH], [GFS] or [FSH])
- Use a sufficiently charged battery.
- The available recording time displayed on the screen may not decrease regularly.
- If data is repeatedly recorded and deleted, the total available recording time on the SD card may be reduced. To restore the original capacity, use the camera to format the SD card. Be sure to save all important data to your computer or other media before formatting, as all data saved to the card will be erased.
- The Optical Image Stabilizer functions regardless of the settings before a motion picture is recorded.
- The following functions are not available:
 - Extra optical zoom, flash, [Face Recog.], [Rotate Disp.] for vertical format pictures.
- For certain memory cards, recording may end while in progress.
- The recording range may become narrower in motion pictures compared to still pictures. Also, if the Aspect Ratio is different for still pictures and motion pictures, the angle of view will change when starting to record a motion picture. The recordable area is displayed by setting [Video Rec Area] (→56) to [ON].
- If Extra optical zoom is used before pressing the motion picture release button, these settings will be cleared, and the recordable area will be changed significantly.
- Depending on the environment when recording motion pictures, the screen may turn black for an instant or noise may be recorded because of static electricity, electromagnetic radiation, etc.

Recording still pictures while a motion picture is being recorded

Still pictures can be recorded even while a motion picture is being recorded.

1 Press the shutter release button fully during the motion picture recording

Still pictures are recorded with an [Aspect Ratio] setting of 16:9 and a [Picture Size] setting of 3.5 M. (Max. 15 pictures)

Motion picture recording continues unchanged.







- The clicking sound made when the shutter release button is operated may be recorded.

If the noise of the camera operation is disturbing, use the touch shutter release function.

- When still pictures are recorded during zooming, the zooming may stop.

■ Serial exposure function

When the serial exposure function has been set in advance, a series of still pictures can be recorded during motion picture recording.

- With the settings , , or , still pictures are automatically recorded using the  setting.
- Even at the  or  settings, the focus setting is based on that for the first picture.

- If the touch shutter release function has been set, still pictures will be recorded if the screen has been touched inadvertently during motion picture recording.
- The camera will refocus if the shutter release button is pressed halfway during motion picture recording or if still pictures are recorded using the touch shutter function. This refocus movement is recorded even during motion picture recording. When priority is to be given to the motion picture videos, press the shutter release button fully, and record the still pictures. Still pictures can also be created after motion picture recording. (→47)
- When the shutter release button is pressed halfway, the resolution and the number of recordable pictures are displayed.
- Still pictures cannot be recorded in the following cases:
 - When [Rec Quality] is set to [VGA]
 - When recording [High Speed Video]
 - [Creative Control] Mode ([Soft Focus])
- The flash is set to  [Forced Flash Off].
- Since the electronic shutter is used for recording, the recordings may be distorted.

Viewing your pictures

[Normal Play]

When a card is in the camera, pictures are played back from the card, without a card, they are played back from the built-in memory.

- Slide the REC/PLAY switch to .

1 Drag your finger across the screen, and select the picture to be played back

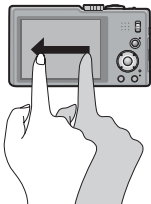



Scrolling to the next picture:

Drag your finger across the screen from right to left.

Returning to the previous picture:

Drag your finger across the screen from left to right.

- If you keep your finger touching the left or right edge of the screen after scrolling the pictures, the pictures will continue to be scrolled. (The pictures are displayed in a reduced size.)

- The pictures can also be scrolled by pressing the   cursor buttons. When the buttons are held down, the pictures can be scrolled quickly forward or backward.



2 View pictures



Folder/File number

Picture number/Total number of pictures

Location name information and latitude & longitude information are provided (→130)

- It may not be possible to view pictures on this camera that were previously edited on a computer.
- If the REC/PLAY switch is moved from  to  while the power is on, the lens barrel will retract after approx. 15 seconds.
- This camera is compliant with the unified DCF (Design rule for Camera File system) standard formulated by the Japan Electronics and Information Technology Industries Association (JEITA), and with Exif (Exchangeable image file format). Files that are not DCF-compliant cannot be played back.

Viewing an enlarged section (Playback Zoom)

1 Touch the area that you want to magnify

Each time you touch, the magnification increases through four levels after 1x: 2x, 4x, 8x, and 16x. (The picture quality displayed becomes successively lower.)

- The area can also be magnified by moving the zoom lever towards T.

2 Drag your finger over the screen to move the position of the area magnified



Current zoom position

Reducing the display magnification rate

Return to the original size (1x)

- The magnification rate can also be reduced by moving the zoom lever towards W.
- The position of the area magnified can also be moved with the respective cursor buttons.

- Playback zoom cannot be used during motion picture playback.

Viewing several reduced pictures (Multi Playback)

1 Move the zoom lever towards the W side



Picture no./Total number of pictures

Slide bar (drag this to change display)

Panorama pictures

Motion pictures

- Move the zoom lever further toward the W side to switch the display modes in the following order: 12-picture screen → 30-picture screen → Calendar playback. (Move the lever towards the T side to return.)
- When a picture is touched on the 12-picture or 30-picture screen, it is displayed in full size.

- Pictures displayed with [!] cannot be played back.

Viewing pictures by their recording date (Calendar Playback)

1 Move the zoom lever towards the W side several times

2 Touch the recording date to be displayed, and [Set] to enter the date

Select the month



The pictures recorded on the selected date appear on the 12-picture screen.

- The recording date can also be selected by using the respective cursor buttons, and pressing [MENU/SET].
- Only months when pictures were taken are shown on the calendar screen. Pictures taken without clock settings are displayed with the date 1st January, 2012.
- Pictures taken with destination settings made in [World Time] are displayed in the calendar screen using the appropriate date for the destination's time zone.

Viewing motion pictures

This camera was designed to play motion pictures using the AVCHD, MP4 and QuickTime Motion JPEG formats.

- Slide the REC/PLAY switch to .

1 Select a picture with the motion picture icon, and touch

Playback now starts.

- You can also press  to play back motion pictures.



Motion picture recording time
Example: After 10 minutes and 30 seconds: [10m30s]







Motion picture icon (differs depending on the recording mode and picture quality setting)

■ Operations during motion picture playback

- ① Touch the screen to display the control panel.
 - ② Touch the control panel to perform playback operations.
- If there is no operation for about 2 seconds, the control panel disappears.



Control Panel

-  : Pause/Play  : Stop
-  : Capturing still pictures from motion pictures (→47)
-  : Fast rewind (2 steps)
-  : Single-frame rewind (while paused)
-  : Fast forward (2 steps)
-  : Single-frame forward (while paused)

Playback bar (The playback position can be moved by touch operation.)

Volume level

Volume adjustment

- You can also use the respective cursor buttons to perform playback operations.
 - ▲: Pause/play
 - ▼: Stop
 - ◀: Fast rewind (2 steps)/Single-frame rewind (while paused)
 - ▶: Fast forward (2 steps)/Single-frame forward (while paused)
 - [MENU/SET]: Capturing still pictures from motion pictures (→47)
- Volume can be adjusted with the zoom lever.

- It may not be possible to properly play back the motion pictures recorded with other cameras.
- Some information will not be displayed for motion pictures recorded in [AVCHD].
- Motion pictures can be viewed on your computer using the supplied software.
- **With camera models 18 176 / 18 177**
Motion pictures recorded with [Miniature Effect] in [Creative Control] Mode play back at approximately 10 times speed.
With camera model 18 175
Motion pictures recorded with [Miniature Effect] in [Creative Control] Mode play back at approximately 8 times speed.

Capturing still pictures from motion pictures

Save a scene from a motion picture as a still picture.

1 Display the picture that you want to capture as a still picture by pausing a motion picture during playback

2 Touch



- A confirmation screen is displayed. Select [Yes] with the respective cursor buttons and then press [MENU/SET].

- You can also capture still pictures from motion pictures by pressing [MENU/SET].

[Rec Quality] of the original motion picture	[Picture Size]	[Aspect Ratio]
[GPH] [GFS] [GS] [PSH] [FSH] [SH] [FHD] [HD]	2 M	16:9
[VGA] [High Speed Video]	0.3 M	4:3

- The picture quality becomes slightly lower depending on the [Rec Quality] setting of the original motion picture.
- It may not be possible to capture still pictures from motion pictures that were recorded with a different camera.

[Video Divide]

A single motion picture take can be split into 2 parts. This is convenient, e.g. when you want to keep just the necessary scenes, or if you wish to delete unnecessary scenes to increase free space on your card, such as when travelling.

1 Select a motion picture to be split and then touch

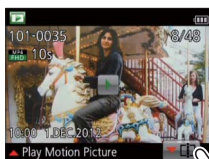

- You can also press ▼ to move to the function for splitting a motion picture.

2 Play back the motion picture and pause at the place to split

3 Touch

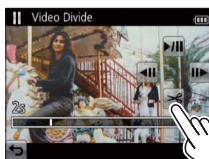

- A confirmation screen is displayed. Select [Yes] with the respective cursor buttons and then press [MENU/SET].
- After being split, the original motion picture take is no longer available.**
(The 2 new parts will be retained separately in memory.)
- You can also press ▼ to split a motion picture.

- During splitting, do not turn off the camera's power or remove the card or battery. If you do so, the motion picture may be deleted.
- Splitting a motion picture recorded in [MP4] or [High Speed Video] changes the order of the pictures. It is recommended to display with [Calendar] (Calendar Playback) or [Filtering Play].
- It may not be possible to split motion pictures that were recorded with a different camera.
- Motion pictures with a short recording time cannot be divided.

Deleting pictures

Pictures will be deleted from the card if one is inserted, or from the built-in memory if no card is inserted. (Deleted pictures cannot be recovered.)



1 Press to delete the displayed picture

Q.MENU



- A confirmation screen is displayed. Select [Yes] with the respective cursor buttons and then press [MENU/SET].

- Do not turn off the power during deletion.
- Use a sufficiently charged battery.
- Pictures cannot be deleted in the following cases:
 - Protected pictures
 - Card switch is in "LOCK" position.
 - Pictures do not comply with the DCF standard (→42)

Deleting multiple (up to 100)/Deleting all pictures

A serial exposure group is handled as one picture. (All the pictures in the selected serial exposure group are deleted.)



1 Press to delete the displayed picture

Q.MENU



2 Use ▲ ▼ to select [Delete Multi]/[Delete All] and press [MENU/SET]



● [Delete Multi]

Use the respective cursor buttons to select picture and press [DISP.] button

 Picture selected

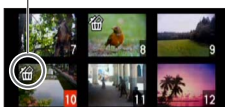

- To cancel → Press [DISP.] button again.
- To execute → Press [MENU/SET].

- You can select [All Delete Except Favorite] in [Delete All] if there are pictures that have been set as [Favorite] (→122).
- A confirmation screen is displayed. Select [Yes] with the respective cursor buttons and then press [MENU/SET].
- The process may take time depending on the number of pictures deleted.

Setting the menu

Refer to the procedure below for an example on how to operate the menus.

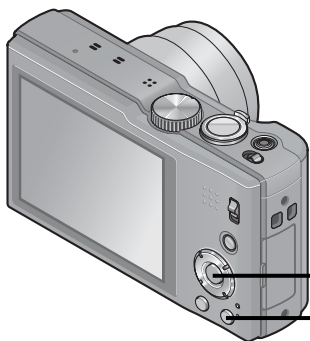

1 Press [MENU/SET]

The menu selection screen is displayed.

2 Use the respective cursor buttons to select a menu, and then press [MENU/SET]

- The menu type can also be selected by touch operations.

3 Use ▲ ▼ to select the menu item, and then press [MENU/SET]

Menu items

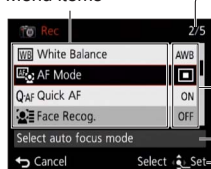

Pages (The pages can also be selected with the zoom lever.)

Current setting

Menu description

Operation guide

- To return to the previous screen, press the [Back / Home] button.

4 Press ▲ ▼ to select a setting, and then [MENU/SET]

The selected setting is set.

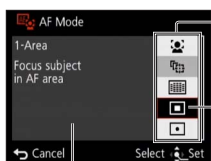

Settings

Selected setting

Setting description

5 Press the [Back / Home] button several times

The menu closes and the monitor returns to the previous screen.

■ Menu selection screen

● In recording mode

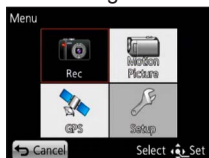

● In playback mode



Menu types

[Rec] menu (→95)

(Recording mode only)

- You can perform settings such as tones, Sensitivity, Aspect Ratio, and resolution.

[Motion Picture] menu (→106)

(Recording mode only)

- You can select the recording mode and picture quality and other settings.

[GPS] menu (→127)

- You can select the GPS setting, location name display and other settings.

[Setup] menu (→54)

- You can perform settings for convenience of use such as the clock setting and changing of the beep sounds.

[Playback Mode] menu (→111)

(Playback mode only)

- Choose [Playback Mode] to see Slide Shows or to narrow down the pictures for display, etc.

[Playback] menu (→117)

(Playback mode only)

- Enables you to specify picture protection, resizing, and other settings for pictures you have taken.

[Map] menu (→145)

(Playback mode only)

- You can display the current location or select a map you want to display.

- The operation screen examples in this manual may differ from the actual screen display or some parts of the screen display are omitted.
- The menu types and items that are displayed vary according to the mode.
- The setting methods vary depending on the menu item.
- In recording mode, the menu screen can also be exited by pressing the shutter release button halfway.
- The following menu is also displayed depending on the recording mode.
 - In the [Scene Mode] mode: [Scene Mode] menu (→78)
 - In the [Custom] mode: [Custom] menu (→85)
 - In the [Creative Control] mode: [Creative Control] menu (→76)

Using the Quick menu

During recording, you can easily call some of the menu items and set them.

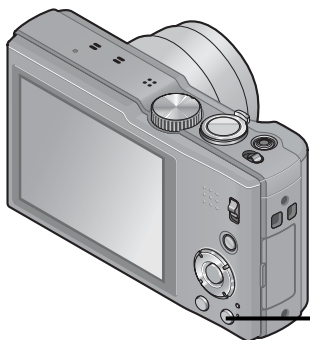

- 1 Press the [Q.MENU] button**
- 2 Press ◀▶ to select a menu item**
 - The menu items and setting items that are displayed differ depending on the recording mode.
- 3 Press ▲▼ to select the settings**





















- 4 Press [MENU/SET]**





Using the [Setup] menu

[Clock Set], [Economy] and [Auto Review] are important for clock setting and battery life. Please check these before use.







- For details about the setting procedure in the [Setup] menu (→51)

Item	Settings, notes
 [Clock Set] (→23)	For setting time, date, and display format.
 [Auto Clock Set] For setting the clock automatically using GPS. (→139)	[ON] / [OFF]
 [World Time] For setting the local time at travel destination. (→93)	 [Destination]: For setting the local time at a travel destination.  [Home]: For setting date and time for the home area.
 [Travel Date] For recording the number of days elapsed in your travels. (→92)	[Travel Setup] [SET] (For registering departure and return dates) / [OFF]
	[Location] [SET] (For entering the name of a location) / [OFF]
 [Beep] For changing or mute the beep/shutter sounds.	[Beep Level]  /  /  : Low / High / Mute
	[Beep Tone]  ① /  ② /  ③: For changing beep tone.
	[Shutter Vol.]  ① /  ② /  ③: Low / High / Mute
	[Shutter Tone]  ① /  ② /  ③: For changing shutter tone.



- For details about the setting procedure in the [Setup] menu (→51)

Item	Settings, notes
 [Volume] For adjusting the speaker volume (7 levels).	[0] / [1] / [2] / [3] / [4] / [5] / [6] <ul style="list-style-type: none"> • Cannot be used to adjust TV speaker volume when connected to a TV.
 [Cust.Set Mem.] For registering settings on current camera. (→85)	[C1] / [C2-1] / [C2-2] / [C2-3]
 [LCD Display] For adjusting brightness and color of the monitor.	<ol style="list-style-type: none"> ① Press ▲ ▼ to select the setting item and ◀ ▶ to make adjustments ② Press [MENU/SET] <ul style="list-style-type: none"> • Some subjects may look different on the monitor, but the recorded picture will not be affected.
 [LCD Mode] For improving the visibility of the monitor image.	<input checked="" type="checkbox"/> *[Auto Power LCD]: The monitor's brightness is adjusted automatically depending on the ambient brightness. <input type="checkbox"/> *[Power LCD]: Makes the monitor image brighter than normal (for outdoor use). [OFF] <ul style="list-style-type: none"> • [Auto Power LCD] cannot be selected in playback mode. • [Power LCD] returns to ordinary brightness if there is no operation for 30 seconds when recording. (Press any button to make the screen brighter again.) • Because the picture shown on the monitor emphasizes brightness, some subjects may look different than their actual appearance, but this will not affect the recorded picture. • Setting [LCD Mode] reduces the operating time.







- For details about the setting procedure in the [Setup] menu (→51)

Item	Settings, notes
 [Guide Line] For selecting recording information display and the types of guidelines.	<p>[Rec. Info.] [ON] (Displays recording information with guidelines.) [OFF]</p> <p>[Pattern]  /  : Changes the patterns of guidelines. • When [Snapshot Mode] is selected, only  is displayed. Also, recording information and guidelines cannot be displayed simultaneously. • This function cannot be used with: [Panorama Shot] scene mode</p>
 [Histogram] For checking brightness in picture on graph. (→62)	<p>[ON] / [OFF]</p>
 [Video Rec Area] For verifying the recordable area for a motion picture before recording.	<p>[ON] / [OFF]</p> <ul style="list-style-type: none"> • The recordable area displayed for motion pictures should be interpreted as a guideline. • When using Extra optical zoom, the recordable area may not always be displayed for certain zoom ratios. • This setting cannot be used with [Snapshot Mode].
 [Zoom Resume] For saving the zoom position when turning the power off.	<p>[ON] / [OFF]</p>





- For details about the setting procedure in the [Setup] menu (→51)

Item	Settings, notes
<p>ECO [Economy]</p> <p>For turning off the power or the monitor while not using the camera to minimize battery consumption.</p>	<p> [Sleep Mode]</p> <p>[2MIN.] / [5MIN.] / [10MIN.] / [OFF]: Automatically switches the camera off when it is not being used.</p> <ul style="list-style-type: none"> • To restore → Press the shutter release button halfway, or turn on the power again. • Cannot be used in the following cases: When connected to a computer/printer, during motion picture recording/playback, during Slide Shows • Settings are fixed to [5MIN.] in [Snapshot Mode]. <hr/> <p> [LCD Power Save]</p> <p>[ON] / [OFF]: The monitor is turned off to minimize power consumption.</p> <ul style="list-style-type: none"> • This reduces the picture quality of the monitor image during recording to minimize battery consumption (except for the Digital Zoom area). Note, however, that there is no effect on the recorded picture. • The setting in [LCD Mode] is prioritized over the setting in [LCD Power Save] for the brightness of the monitor.
<p> [Auto Review]</p> <p>For having still pictures displayed immediately after taking them.</p>	<p>[1SEC] / [2SEC]</p> <p>[HOLD]: The auto review screen remains until a button (other than the [DISP.] button) is pressed</p> <p>[OFF]</p> <ul style="list-style-type: none"> • The following cases are fixed to the settings indicated below. [Snapshot Mode]: [2SEC] Scene Mode [Panorama Shot]: [2SEC] • Still pictures are automatically displayed immediately after they are taken regardless of the [Auto Review] setting in [Auto Bracket], [Burst] mode, and [Handheld Night Shot] and [HDR] Scene Modes. • Motion pictures cannot be reviewed automatically.







- For details about the setting procedure in the [Setup] menu (→51)

Item	Settings, notes
 [No.Reset] For resetting picture file numbers.	<ul style="list-style-type: none"> • The folder number is updated and the file number starts from 0001. • A folder number between 100 and 999 can be assigned. Numbers cannot be reset once folder number reaches 999. In this case, save all necessary pictures to your computer, and format the built-in memory/the card (→60). • To reset folder number to 100: First, format the built-in memory or the card, then reset the file numbers using [No.Reset]. Finally, select [Yes] on the folder number reset screen.
 [Reset] For resetting to the default settings.	<p>[Reset Rec. settings?]</p> <p>[Reset setup parameters?]</p> <ul style="list-style-type: none"> • Information registered in [Face Recog.] is reset if recording settings are reset. • Resetting the setup parameters will also reset the following: <ul style="list-style-type: none"> - Age in years/months and names in [Baby] and [Pet] Scene Modes, [GPS] menu, [Map] menu • Folder numbers and clock settings will not be reset. • Camera movement may be audible as the lens function is reset. This is not a fault.
 [USB Mode] For selecting a communication method for when connecting the camera to a computer or printer with the USB connection cable. Update the GPS assist data.	<p> [Select on connection]: Selects the communication method each time you connect to a computer or PictBridge-compatible printer.</p> <p> [PictBridge(PTP)]: Selected when connected to a PictBridge-compatible printer.</p> <p> [PC]: Selected when connected to a computer.</p> <p> [GPS assist data]: Updates the GPS assist data. (→140)</p>



- For details about the setting procedure in the [Setup] menu (→51)

Item	Settings, notes
<p> [Output]</p> <p>Changes the settings to be used when the camera is connected to a TV or an other device.</p>	<p> [Video Out] (With camera model 18 175)</p> <p>[NTSC] / [PAL]</p> <p>If the default setting is changed, AVCHD motion pictures may not be played correctly.</p> <p> [TV Aspect] (This setting is performed when the AV cable (included in scope of delivery) is connected.)</p> <p>16:9 / 4:3</p>
<p><small>HDTV Link</small> [HDTV Link]</p> <p>For enabling automatic linking with other HDTV Link-compatible devices, and operability with a HDTV remote control when connected via the HDMI mini cable (available as accessory →9) (→157).</p>	<p>[ON]: Operations may be performed via the remote control of the HDTV Link-compatible device. (Not all operations will be available.) Operability of the camera's own buttons will be limited.</p> <p>[OFF]: Operations must be performed via the camera's own buttons.</p>
<p> [3D Playback]</p> <p>For determining how a 3D still picture is output.</p>	<p>[3D] / [2D]</p> <ul style="list-style-type: none"> • If you want to play back a picture in 2D (conventional picture) on a 3D television, set to [2D]. • This item of the menu functions when the HDMI mini cable (available as accessory →9) is connected. • For the procedure for playing back a 3D still picture (→159).

- For details about the setting procedure in the [Setup] menu (→51)

Item	Settings, notes
 [Rotate Disp.] For having portrait-format still pictures rotated automatically.	  : Rotates and displays pictures taken in portrait format when displayed on a TV screen or on the monitor of the camera.  : Rotates and displays only pictures displayed on a TV screen. [OFF] <ul style="list-style-type: none"> • [Rotate Disp.] cannot be used with motion pictures. • Still pictures taken with the camera facing up or down, or those taken on other cameras may not be rotated. • Pictures cannot be rotated during Multi Playback. • Pictures will only be displayed rotated on a computer if in Exif-compatible (→42) environment (OS, software).
 [Version Disp.] For checking the camera firmware version or displaying the software information.	The current version is displayed. <ul style="list-style-type: none"> • When you press [MENU/SET] while the version is displayed, software information such as the license is displayed.
 [Format] Use when [Built-In Memory Error] or [Memory Card Error] appears, or when formatting the built-in memory or card. When a card/the built-in memory is formatted, the data cannot be restored. Check the content of the card/ the built-in memory carefully before formatting.	<ul style="list-style-type: none"> • This requires a sufficiently charged battery. When formatting the built-in memory, remove the card. (Only the card will be formatted if inserted; if not, only the built-in memory will be formatted.) • Always format the cards that are to be used in this camera with this camera. • All data including protected pictures and copied map data will be deleted. • Do not turn off power or perform other operations during formatting. • Formatting the built-in memory may take several minutes. • Consult your Leica dealer or the nearest Leica Customer Care center if formatting cannot be successfully completed.

- For details about the setting procedure in the [Setup] menu (→51)

Item	Settings, notes
 [Language] For changing the display language.	Sets the language displayed on the screen.
 [O.I.S. Demo.] For viewing a demonstration of functions.	Extent of camera shake is shown on graph (estimate)  <ul style="list-style-type: none"> Extent of camera shake Extent of camera shake after correction <ul style="list-style-type: none"> • During a demo screen display, the Optical Image Stabilizer switches ON and OFF every time [MENU/SET] is pressed. • This cannot be displayed during playback mode.

Changing recording information display

For switching between different monitor displays, such as Histograms.

1 Press the [DISP.] button to change the display

● In Recording Mode

Recording information*1

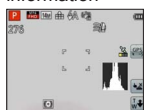

Motion picture recording information*1,*2



No display



Guide lines*1,*3



● In Playback Mode

Picture information

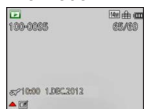

Recording information*1



No display

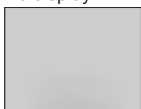

*1 Set [Histogram] to display a histogram. (→56)

*2 Return to the "Recording information" display by pressing the shutter release halfway.

*3 About [Guide Line] (→56)

- During Playback Zoom, Motion Picture Playback, Slide Show: You can only turn the display on and off.
- During menu display, Multi Playback or Calendar Playback: The display cannot be changed.

■ Histogram

Displays the distribution of brightness in the picture – e.g. if the graph peaks at the right, this means there are several bright areas in the picture (Guide). A peak in the center represents correct brightness (correct exposure). This can be used as a reference for exposure compensation, etc. (→71)

(Example)

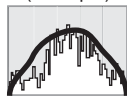

Dark ← OK → Bright

- The histogram at the time of recording is different than the one in playback and it is displayed in orange, when recording with flash or in dark locations. Also, the histogram may differ from those made with image editing software.
- The histogram is not displayed when using **[A]** ([Snapshot Mode]) or Playback Zoom.

Using the zoom

Recording modes: **A P A S M C1 C2 3D SCN** 

You can determine how much of a subject you wish to capture by using the lens's zoom function.

1 Zooming in/out

For capturing a larger area (wide-angle)



For capturing a smaller, but also enlarged area (telephoto)

- The zoom speed is determined by how far the zoom lever is rotated; two setting speeds are available.

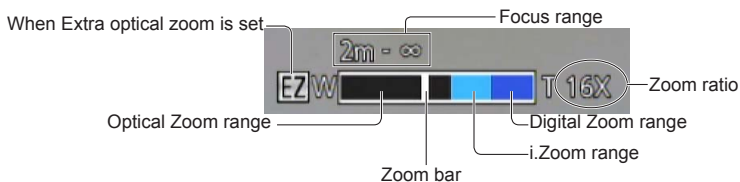

- Adjust the focus after zooming.
- Do not touch the lens barrel during zooming.
- The zoom ratio and the zoom bar displayed on the screen are approximations.
- The camera may make a noise and vibrate when the zoom lever is operated - this is not a malfunction.



Zooming with touch operation

1 Touch 

The zoom bar appears on the screen.

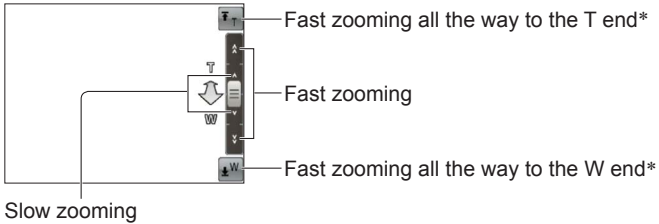
2 Touch the T or W edge of the zoom bar on the screen



* When  or  is touched again while zooming, zooming will stop.

Zoom modes and their application

The zoom ratio changes when the resolution is changed.



■ Optical zooming

Zooming up to a ratio of 20x is possible if recording without **[Z]** is selected with [Picture Size] in the [Rec] menu. (→95)

- Optical zooming is not available in the following cases:
 - Scene Mode ([Panorama Shot])
 - [Macro Zoom]

■ Extra optical zoom



Zooming up to a ratio of 42.2x is possible when recording with **[EZ]** is selected with [Picture Size] in the [Rec] menu (→95). EZ is short for “Extra optical zoom”.

- Extra optical zoom cannot be used in the following cases:
 - [Snapshot Mode] (when [Motion Deblur] is [ON])
 - [Macro Zoom] • Motion picture • When [Burst] is set to , , or 
 - Scene Modes ([Panorama Shot] [HDR] [High Sens.] [High Speed Video])
 - [Creative Control] Mode ([Toy Effect])

To increase the zoom ratio further, the following zoom modes can be used in combination.



■ [i.ZOOM]

You can use the camera's Intelligent Resolution technology to increase the zoom ratio up to 2x higher than the original zoom ratio with limited deterioration of picture quality. Set [i.Resolution] to [i.ZOOM] in the [Rec] menu. (→102)

- When [i.Resolution] is set to [i.ZOOM], Intelligent Resolution technology is applied to the picture.
- [i.ZOOM] does not function in the following cases.
 - [Snapshot Mode] (when [Motion Deblur] is [ON])
 - Scene Modes ([Panorama Shot] [Handheld Night Shot] [HDR] [High Sens.])
 - When [Burst] is set to , , or 
 - [Creative Control] mode ([Toy Effect])
 - [Macro Zoom]

■ [Digital Zoom]





This mode allows zooming ratios 4x higher than Optical/Extra optical zoom. Note that, with Digital Zoom, enlarging will decrease picture quality. Set the [Digital Zoom] in the [Rec] menu to [ON]. (→102)

- Digital Zoom cannot be used in the following modes:
 - [Snapshot Mode] • When [Burst] is set to , , or 
 - Scene Modes ([Panorama Shot] [Handheld Night Shot] [HDR] [High Sens.] [High Speed Video])
 - [Creative Control] mode ([Toy Effect] [Miniature Effect])
- When Digital Zoom is used simultaneously with i.Zoom, you can only increase the zoom ratio up to 2x.

Taking pictures with flash

Recording modes: **A P A S M Cl C2 3D SCN** ↻

- 1 Press **▶** to display [Flash]
- 2 Use the respective cursor buttons to select the desired mode and press **[MENU/SET]**

Type, operations	Uses
 [Auto] • Flash is activated automatically when necessary	For normal use
 [Auto/Red-Eye]*1 • Flash is activated automatically when necessary plus pre-flash to reduce red eye effect	For taking pictures of subjects in dark places
 [Forced Flash On] • Flash always fires	For taking pictures with backlight or under bright lighting (e.g. fluorescent)
 [Slow Sync./Red-Eye]*2 • Flash is activated automatically when necessary, plus pre-flash to reduce red eye effect, slower shutter speeds may be used for a correct rendition of dark backgrounds	For taking pictures of persons in a dark environment (using a tripod is recommended)
 [Forced Flash Off] • Flash never fires	For taking pictures in places where the use of flash is prohibited or inappropriate

*1 Only in the **A** mode

*2 Two flashes will be emitted. Photographer and subject should not move until after the second flash. The interval between flashes varies according to the subject brightness.

If [Red-Eye Removal] in the [Rec] menu is [ON],  appears with the flash icon, red-eye is automatically detected and still picture data is corrected. (Only when [AF Mode] is  (Face Detection))

- **Do not put your hands over the flash reflector (→10) or look at it from close range (from a few centimeters away). Do not use the flash at close distances to other subjects (heat/light may damage the subject).**
- The picture edges may be rendered darker in flash pictures with near maximum wideangle setting. This may be remedied by zooming a little toward telephoto.
- The effect of red-eye reduction varies depending on the subject and is affected by factors such as distance to the subject, whether the subject is looking at the camera during preliminary flash, and so on. In some cases, the effect of red-eye reduction may be negligible.
- Flash modes may change when recording modes are changed.
- Scene Mode flash modes are restored to default when the Scene Mode is changed.
- No pictures can be taken when the mode icons (e.g. ) are flashing (flash is charging).
- If the flash illumination for the subject is insufficient, both the exposure and white balance settings may be faulty.
- The flash effect may not be sufficient in the following cases:
 - Slow shutter speed
 - [Flash Burst] is set
- Flash charging may take time if battery capacity is low, or when the flash is used in quick succession.

Taking close-up pictures

Recording modes: **A P A S M C1 C2 3D SCN**

When you want to enlarge the subject, setting to [AF Macro] (AF) enables you to take pictures at an even closer distance than the normal focus range (up to 3 cm (1¹/₃₂ inch) for max. W).

1 Press to display [Macro Mode]

2 Use the respective cursor buttons to select [AF Macro] and press [MENU/SET]



AF display

■ Taking close-up pictures without being close to the subject

“Tele macro” operates automatically when you increase the zoom ratio to 12 times or higher while [AF Macro] is set, enabling the camera to focus on a subject as close as 1 m (3.3 feet).

(AF changes to TELE)

Focus range

When a subject is too close to the camera, the picture may not be properly focused. The shortest recording distance differs depending on the zoom ratio and the setting in macro recording mode.

■ Shortest focusing distance

The shortest focusing distance is the distance from the lens front to the subject. This distance changes gradually depending on the zoom position. At the time of zooming, even if [Macro Mode] is set to [AF Macro] (AF) , the shortest focusing distance is the same as when the mode is set to OFF (2 m (6.6 feet) when the optical zoom magnification of 5x to 7x is used).

Zoom	[Macro Mode]	
	AF	OFF
Max. W	3 cm (1 ¹ / ₃₂ inch)	50 cm (1.6 feet)
Max. T	1 m (3.3 feet)	2 m (6.6 feet)

- The focus range is displayed when operating the zoom, etc.

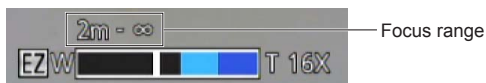

- It may take some time until distant subjects come into focus.
- Using a tripod and [Selftimer] is recommended. Also, when recording a subject that is close to the camera, setting [Flash] to [Forced Flash Off] is recommended.
- Moving the camera after focusing is likely to result in poorly focused pictures if the subject is close to the camera, due to the reduced depth of field.
- The sharpness may be reduced around the edges of the picture.

[Macro Zoom]

To take even larger images of the subject than when using [AF Macro], select [Macro Zoom].

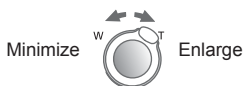

- 1 Press **▼** to display [Macro Mode]
- 2 Use the respective cursor buttons to select [Macro Zoom] and press [MENU/SET]
- 3 Adjust the Digital Zoom magnification with the zoom lever



The zoom position is fixed at the Wide end.

Focus range is 3 cm (1¹/₃₂ inch) - ∞.

Digital Zoom magnification (1 x to 3 x)

- In [Macro Zoom], higher magnification results in lower picture quality.
- When [Macro Zoom] is set, Extra optical zoom or [i.ZOOM] does not work.
- [Macro Zoom] cannot be set in the following cases:
 - [Creative Control] mode ([Toy Effect] [Miniature Effect])
 - [3D Photo Mode]
 - When [Burst] is set to , , or 
- When [AF Tracking] is set, zoom macro is cancelled.

Taking pictures with the self-timer

Recording mode: **A P A S M C1 C2 3D SCN**

We recommend using a tripod. This mode can also be used to prevent the camera shake effect caused by pressing the shutter release button. To do so, set the self-timer to 2 seconds.

- 1 Press ◀ to display [Selftimer]**
- 2 Use the respective cursor buttons to select time duration and press [MENU/SET]**
- 3 Take a picture**
Press the shutter release button fully to start recording after the preset time.

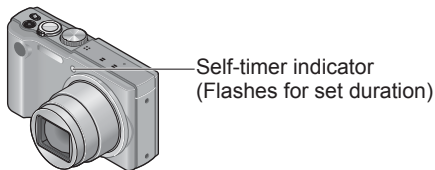

- To cancel while in operation → Press [MENU/SET]

- Focusing is done automatically immediately before recording if the shutter release button is pressed fully.
- After the Self-timer indicator stops flashing, it may then be lit in its function as AF Assist Lamp.
- This function cannot be used in the following cases:
 - With the [High Speed Video] scene mode
 - When recording motion pictures

Taking pictures with Exposure Compensation

An exposure compensation allows adjusting the exposure when the desired brightness level is not attained automatically (e.g. when there are different brightness levels within the picture).

■ Recording modes: **A** **P** **A** **S** **M** **C1** **C2** **3D** **SCN** 

1 Press **▲** to display [Exposure]

2 Use the respective cursor buttons to select a value and press [MENU/SET]



- If the main subject is too dark, adjust the exposure to the “+” direction.
- If the main subject is too bright, adjust the exposure to the “-” direction.
- When an exposure compensation is set, the compensation value ($\frac{2}{3}$ EV for example) is displayed in the bottom-left corner of the screen.

- Depending on the brightness, it may not be possible to set an exposure compensation in some cases.
- The Exposure Compensation value you set is retained even after the camera is turned off.

Taking picture series with automatically changed exposure

3 pictures in continuous succession are recorded while the exposure is changed automatically.

If an exposure compensation value is set, the adjusted exposure is set as the standard.

■ **Recording modes:** **A** **P** **A** **S** **M** **C1** **C2** **3D** **SCN** **🔗**

1 Press **▲** several times to display **[Auto Bracket]**

2 Use the respective cursor buttons to select a value and press **[MENU/SET]**

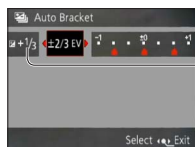

Value displayed when an exposure compensation value is set

- The first picture is recorded without compensation, the second with the exposure adjusted in the “-” direction, and the third with the exposure adjusted in the “+” direction.
- The bracketing mode is canceled when the power is turned off.

- Bracketing cannot be used with flash.
- When [Auto Bracket] is set, [Burst] is canceled.
- [Auto Bracket] cannot be used in the following cases:
 - [Creative Control] Mode ([Miniature Effect] [Soft Focus])
 - Scene Modes ([Panorama Shot] [Handheld Night Shot] [HDR] [High Speed Video])
 - When recording motion pictures

Using a pre-set aperture to determine the depth of field - [Aperture-Priority] Mode

Recording mode:  P  A S M C1 C2 3D SCN 

By setting the aperture value manually, you can determine the depth of field (i.e. how much of the subject is rendered sharply) to suit your compositional intentions. The shutter speed is automatically adjusted accordingly.

1 Set the mode dial to **A** ([Aperture-Priority] Mode)

2 Press the [EXPOSURE] button and use the respective cursor buttons to determine aperture value



- When the aperture value is increased, the depth of field expands, so that more of the back- and foreground appear sharp.
- When the aperture value is reduced, the depth of field decreases, so that less of back- and foreground appear sharp.

3 Press the [EXPOSURE] button

- When the picture is too bright or too dark, indicating an incorrect exposure, the aperture and shutter speed values are shown in red.
- The brightness of the monitor image may differ from the actual picture recorded.

Using a pre-set shutter speed to determine the rendition of moving subjects - [Shutter-Priority] Mode

Recording mode: **A** P A **S** M C1 C2 3D SCN

By setting the shutter speed manually, you can determine how sharp moving subjects are rendered. The aperture value is automatically adjusted accordingly.

1 Set the mode dial to **S** ([Shutter-Priority] Mode)

2 Press the [EXPOSURE] button and use the respective cursor buttons to determine shutter speed



Shutter speed

- Faster shutter speeds render moving subjects sharper (depending on their speed).
- Slower shutter speeds render moving subjects increasingly unsharp.

3 Press the [EXPOSURE] button

- When the picture is too bright or too dark, indicating an incorrect exposure, the aperture and shutter speed values are shown in red.
- The brightness of the monitor image may differ from the actual picture recorded.

Using a pre-set aperture/shutter speed combination to achieve full control of the exposure - [Manual Exposure] Mode

Recording mode: M C1 C2 3D SCN

This mode, in which you set both aperture and shutter speed manually gives you full control of the exposure, i.e. of how bright a subject is rendered. Also, long-exposure recording of up to 15 seconds is possible.

1 Set the mode dial to M ([Manual Exposure] Mode)

- Manual exposure assist is displayed.

2 Press the [EXPOSURE] button and use the respective cursor buttons to determine aperture value and shutter speed

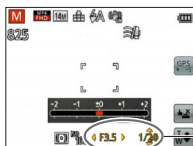

Aperture value/shutter speed

3 Press the [EXPOSURE] button

■ Manual exposure assist (estimate)

If the shutter release button is pressed halfway, manual exposure assist is displayed.

	Indicates exposures with standard brightness.
	Indicates a brighter exposure. For standard brightness, either use a faster shutter speed or increase the aperture value.
	Indicates a darker exposure. For standard brightness, either use a slower shutter speed or reduce the aperture value.

- When the picture is too bright or too dark, indicating an incorrect exposure, the aperture and shutter speed values are shown in red.
- The brightness of the monitor image may differ from the actual picture recorded.

Taking Pictures with different picture effects

[Creative Control] mode

Recording mode: P A S M C1 C2 3D SCN

You can select various effects for taking pictures and get the results displayed on the monitor.

1 Set the mode dial to

2 Press to select a setting, and then [MENU/SET]



Setting	Effect
[EXPS] [Expressive]	This effect creates a pop art style picture that enhances the color.
[RETR] [Retro]	This effect creates the soft appearance of a tarnished picture.
[HKEY] [High Key]	This effect creates a brighter and lighter toned appearance for the entire picture.
[LKEY] [Low Key]	This effect creates a darker somber appearance for the entire picture to emphasize the bright portions.
[SEPI] [Sepia]	This effect creates a picture with sepia tone.
[MONO] [Dynamic Monochrome]	This effect creates a monochromatic picture with a higher contrast and more dramatic atmosphere.
[HDYN] [High Dynamic]	This effect creates a picture with a well-balanced brightness for the entire picture (from dark to bright areas).
[TOY] [Toy Effect]	This effect creates a picture that resembles those taken by a toy camera with a reduced amount of peripheral light. • About adjusting color hue → Press the [DISP.] button and use the respective cursor buttons to select the color hues.
[MINI] [Miniature Effect]	This effect creates a diorama-like picture by intentionally blurring the outer areas on the picture. (Also known as Tilt Shift Focus)
[SOFT] [Soft Focus]	This effect creates a soft appearance by intentionally blurring the entire picture.

■ Changing the selected picture effects ([Creative Control] menu)

- ① Press [MENU/SET]
- ② Use the respective cursor buttons to select [Creative Control] menu and press [MENU/SET]
- ③ Press ▲ ▼ to select a setting, and then [MENU/SET]

■ Recording motion pictures in

This mode records a motion picture at the optimum settings for the selected effects.

- A setting that was selected in [Creative Control] mode is retained even after the camera is turned off.
- The following [Rec] menu settings will be automatically adjusted and cannot be selected manually.
[Sensitivity], [White Balance], [i.Exposure], [Min. Shtr Speed], [Color Mode]
- Notes on the [Miniature Effect] setting
 - The recording screen is displayed with a slight delay when compared to usual recording.
 - No audio is recorded for motion pictures.
 - **With camera models 18 176 / 18 177**
When a motion picture is recorded, the finished recording will be approximately 1/10th of the actual recorded time period. (If you record a motion picture for 10 minutes, the resulting motion picture recording time will be approximately 1 minute.) The recordable time displayed by the camera is approx. 10 times longer than actual time needed for recording. When the recording mode is changed, be sure to check the recordable time.
 - **With camera model 18 175**
When a motion picture is recorded, the finished recording will be approximately 1/8th of the actual recorded time period. (If you record a motion picture for 8 minutes, the resulting motion picture recording time will be approximately 1 minute.) The recordable time displayed by the camera is approx. 8 times longer than actual time needed for recording. When the recording mode is changed, be sure to check the recordable time.
- If you stop recording motion pictures too soon, the camera may continue recording for a certain time. Hold the camera still until the camera stops recording.
- When you take a picture using a high resolution setting, the screen will become dark for a certain period of time after the picture is taken. However, this occurs due to signal processing and is not a defect.
- Notes on the [Soft Focus] setting
 - The recording screen is displayed with a slight delay when compared to usual recording. (When this effect is set, the recorded motion picture is played back like a frame dropping.)
 - When you take a picture using a high resolution setting, the screen will become dark for a certain period of time after the picture is taken. However, this occurs due to signal processing and is not a defect.

Taking pictures with settings matched to the encountered scene [Scene Mode]

Recording mode: P A S M C1 C2 3D SCN

Using [Scene Mode] enables you to take pictures with optimum settings (exposure, coloring, etc.) for given scenes.

1 Set the mode dial to SCN

2 Use the respective cursor buttons to select the scene and press [MENU/SET]

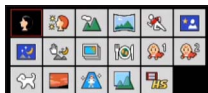

■ Changing the selected scene mode ([Scene Mode] menu)

- ① Press [MENU/SET]
- ② Use the respective cursor buttons to select the [Scene Mode] menu and press [MENU/SET]
- ③ Use the respective cursor buttons to select the scene and press [MENU/SET]

■ Recording motion pictures in SCN

This mode records a motion picture at the optimum settings for the selected scene.





- Some scenes are switched to the following scenes:

Selected scene	Scenes for motion picture
[Baby]	Portrait motion picture
[Night Portrait], [Night Scenery], [Handheld Night Shot]	Low light motion picture
[Sports], [HDR], [Pet]	Normal motion picture

- Selecting a Scene Mode inappropriate for the actual scene may affect the coloring of your picture.
- The following [Rec] menu settings will be automatically adjusted and cannot be selected manually.
[Sensitivity], [Metering Mode], [i.Exposure], [Min. Shtr Speed], [i.Resolution], [Color Mode]
- About using flash in Scene Modes (→67)

Taking pictures with settings matched to the encountered scene [Scene Mode]

- How to select a scene (→78)
- About using flash in Scene Modes (→66)

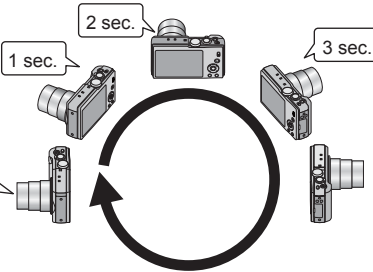
 [Portrait]	<p>This mode improves the skin tone of subjects for a healthier appearance in bright daylight conditions.</p> <p>Tip</p> <ul style="list-style-type: none"> • The larger the zoom factor in use is and the closer the subject is to the camera, the greater the effect will be.
 [Soft Skin]	<p>This mode smooths skin colors in bright, outdoor daylight conditions (portraits from chest upwards).</p> <p>Tip</p> <ul style="list-style-type: none"> • The larger the zoom factor in use is and the closer the subject is to the camera, the greater the effect will be.
 [Scenery]	<p>This mode takes sharp pictures of wide, distant subjects.</p>
 [Panorama Shot]	<p>This mode creates a single panorama picture by stitching together several pictures taken in rapid succession.</p> <ol style="list-style-type: none"> ① Use the respective cursor buttons to select the recording direction, and press [MENU/SET] to set. ② Check the recording direction and press [MENU/SET] <ul style="list-style-type: none"> • Special panorama guidelines will be displayed during recording. ③ Press the shutter release button halfway to focus ④ Press the shutter release button fully and pan the camera in a small circular motion in the selected direction to start recording <ul style="list-style-type: none"> • Taking pictures from left to right <div style="border: 1px solid black; padding: 5px; margin: 10px 0;"> <p>Pan the camera so that you make a complete circuit in approx. 8 seconds</p> <ul style="list-style-type: none"> • Pan the camera at a constant speed. • You may not be able to take pictures successfully if you move the camera too quickly or too slowly. • Pan the camera in a small circular motion. </div>  <ol style="list-style-type: none"> ⑤ Press the shutter release button fully again to end recording <ul style="list-style-type: none"> • You can also end recording if you stop panning the camera while taking pictures.

Taking pictures with settings matched to the encountered scene [Scene Mode]

- How to select a scene (→78)
- About using flash in Scene Modes (→66)

Tip

- Pan the camera in the recording direction as steadily as possible.

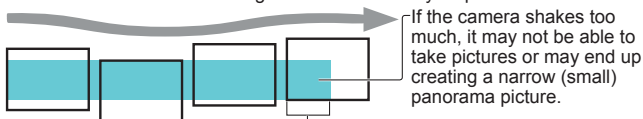

The subjects displayed within the guideline are recorded.

Notes

- The zoom position is fixed to the shortest focal length / maximum W setting.
- The focus, White Balance, and Exposure Compensation are all fixed to optimal values for the first picture.

If the focusing or brightness of pictures recorded as part of a panorama picture after the first picture are significantly different from those of the first picture, the panorama picture as a whole (when all pictures are stitched together) may not have consistent focus and brightness.

- The following functions are fixed to the settings indicated below.
[Stabilizer]: [OFF] [Date Stamp]: [OFF]
- Since several pictures are stitched together to create a panorama picture, some subjects may be distorted or the joining portions of pictures taken successively that are stitched may be noticeable.
- The number of recording pixels per horizontal line and vertical line of a panorama picture varies depending on the recording direction and number of stitched pictures.
The maximum number of recording pixels is as follows:
 - Taking pictures in landscape orientation: Approx. 8000 x 1080
 - Taking pictures in portrait orientation: Approx. 1440 x 8000
- Panorama pictures may not be created or pictures may not be recorded properly when taking pictures of the following subjects or when taking pictures in the following recording conditions:
 - Uniform subjects or those containing a pattern (sky, beach, etc.)
 - Moving subjects (persons, pets, vehicles, waves, or flowers swaying in the wind, etc.)
 - Subjects whose colors or patterns change quickly (such as an image appearing on a display)
 - Dark locations
 - Locations with a flickering light source (fluorescent lamp, candle light, etc.)

About panorama playback

You can operate the zoom lever or perform touch operations to enlarge still pictures taken in [Panorama Shot] scene mode in the same way as with other still pictures. If you play back panorama pictures in the same way as playing back a motion picture, the panorama pictures are scrolled automatically. (→45)

- Unlike motion picture playback, you cannot perform fast forward or fast rewind while the panorama pictures are scrolling automatically. (You can perform single-frame forward or rewind while the automatic scrolling operation is paused.)







[Panorama Shot]

(Continued)





Taking pictures with settings matched to the encountered scene [Scene Mode]

- How to select a scene (→78)
- About using flash in Scene Modes (→66)

 [Sports]	<p>This mode is for pictures of scenes with fast movement, e.g. sports.</p> <p>Tip</p> <ul style="list-style-type: none">• Stand at least 5 m (16 feet) away. <p>Note</p> <ul style="list-style-type: none">• The shutter speed may slow down up to 1 second.
 [Night Portrait]	<p>This mode is for pictures of people and nightscapes with close to actual brightness.</p> <p>Tips</p> <ul style="list-style-type: none">• Use flash.• The subject should not move.• Using a tripod and/or the self-timer is recommended. <p>Notes</p> <ul style="list-style-type: none">• The shutter speed may slow down up to 8 seconds.• After recording, the shutter may stay closed (up to 8 seconds) to process the signal. This is not a malfunction.
 [Night Scenery]	<p>This mode is for sharp pictures of night scenes.</p> <p>Tip</p> <ul style="list-style-type: none">• Using a tripod and/or the self-timer is recommended. <p>Notes</p> <ul style="list-style-type: none">• The shutter speed may slow down up to 8 seconds.• After recording, the shutter may stay closed (up to 8 seconds) to process the signal. This is not a malfunction.
 [Handheld Night Shot]	<p>This mode is for sharp still pictures of night scenes with less camera shake and less noise by combining a burst of still pictures.</p> <p>Tips</p> <ul style="list-style-type: none">• Stand at least 5 m (16 feet) away.• After the shutter release button is pressed, serial exposures commence. Hold the camera still during the complete process. <p>Note</p> <ul style="list-style-type: none">• Since a series of still pictures are combined after they are recorded, it will take a few moments before you can take another picture.





Taking pictures with settings matched to the encountered scene [Scene Mode]

- How to select a scene (→78)
- About using flash in Scene Modes (→66)

 [HDR]	<p>In this mode, the camera can combine several still pictures taken with different exposures into a single picture with rich gradation.</p> <p>Tip</p> <ul style="list-style-type: none"> • After the shutter release button is been pressed, serial exposures commence. Hold the camera still during the complete process. <p>Notes</p> <ul style="list-style-type: none"> • Since a series of still pictures are combined after they are recorded, it will take a few moments before you can record another picture. • A subject that was in motion when it was recorded may be rendered as a double/multiple exposure. • The camera may take a single still picture instead of several pictures under certain recording conditions.
 [Food]	<p>For taking natural-looking pictures of food.</p>
  [Baby]	<p>This mode uses reduced flash output to bring out skin colors.</p> <p>■ To record age and name [Baby1] and [Baby2] can be set separately.</p> <ol style="list-style-type: none"> ① Select [Age] or [Name] with the respective cursor buttons, press [MENU/SET], select [SET], and press [MENU/SET]. ② Set the birthday and name. Age: Set birthday with the respective cursor buttons, and press [MENU/SET]. Name: (See "Entering Text": (→94)) ③ Use the respective cursor buttons to select [Exit] and press [MENU/SET]. <p>Tip</p> <ul style="list-style-type: none"> • Make sure [Age] and [Name] are [ON] before taking a picture. <p>Notes</p> <ul style="list-style-type: none"> • The age display format depends on [Language] setting. • The shutter speed may slow down up to 1 second. • A text can be stamped onto the still picture using [Text Stamp].
 [Pet]	<p>This mode records a pet's age and name when taking pictures.</p> <ul style="list-style-type: none"> • Refer to [Baby] for other tips and notes.

Taking pictures with settings matched to the encountered scene [Scene Mode]

- How to select a scene (→78)
- About using flash in Scene Modes (→66)

 [Sunset]	<p>For taking sharp pictures of scenes such as sunsets.</p>
 [High Sens.]	<p>This mode prevents blurring of subjects in dark, indoor conditions.</p> <p>Select the aspect ratio and the picture size with cursor button and press [MENU/SET].</p>
 [Through window]	<p>This mode is recommended for taking pictures through a window of a train/vehicle or building.</p> <p>Notes</p> <ul style="list-style-type: none"> • If there are stains such as dust or a reflection on the window, the camera may focus on the window surface instead of a subject. • The color of pictures may appear unnatural due to the color of the window material. (You may be able to reproduce the appropriate color by adjusting the White Balance.)
 [High Speed Video]	<p>This mode records at a high speed of 220fps, making it ideal for capturing the details of rapid movements.</p> <p>① Press the motion picture release button to start recording</p> <p>② Press it again to stop recording</p> <ul style="list-style-type: none"> • Motion picture recording can also be started or stopped by pressing the shutter release button. (The touch shutter function will be disabled.) • During playback, details of a subject's movements that cannot be seen by the naked eye can be made recognizable by playing back the motion pictures using slow motion. <p>Notes</p> <ul style="list-style-type: none"> • High-speed motion pictures cannot be saved to the built-in memory. • Motion pictures are recorded in Motion JPEG with a resolution of QVGA (320x240 pixels). (Up to 2 GB, about 7 minutes 20 seconds at one recording.) • No sound is recorded. • Still pictures cannot be recorded while high-speed motion pictures are being recorded. • The settings for the focus, zoom, exposure and White Balance are fixed to the settings specified when recording was started. • The Optical Image Stabilizer does not work. • The [AF Mode] is set to  (1-area-focusing). • Flickering or horizontal stripes may appear while recording under fluorescent lighting.

Taking 3D pictures

[3D Photo Mode]

Recording mode: P A S M C1 C2 SCN

The camera continuously records multiple still pictures while being moved horizontally, and combines two of them into a 3D still picture.

To view 3D pictures, a television that supports 3D is required (This camera will play back in 2D). (→159)

1 Set the mode dial to

- A description of the method is displayed.
Check the instructions, and then press [MENU/SET].

2 Start the recording and then pan the camera horizontally straight from left to right

- A guide is displayed while recording.
- Move the camera approximately 10 cm (4 inches) within approximately 4 seconds using the guide.

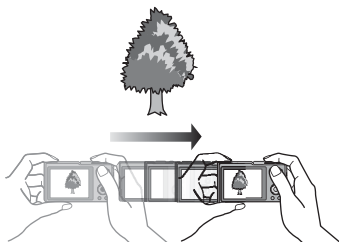

Tips for 3D pictures

- Select a stationary subject.
- Take pictures with this mode outdoors or in other bright locations.
- Press the shutter release button halfway to fix the focus and the exposure, press it fully, and then pan the camera.
- Hold the camera so that the subject is slightly to the right of the center on the display at the start of the recording. This makes it easier to position the subject in the center of the recorded picture.

- **3D still pictures cannot be taken when holding the camera vertically.**
- 3D still pictures are recorded in MPO format (3D).
- The zoom position is fixed to the shortest focal length / maximum W setting.
- The aspect ratio is fixed to 2 M .
- ISO Sensitivity is automatically adjusted. However, it is increased to allow faster shutter speeds.
- Motion pictures cannot be recorded.
- When any of the recording conditions listed below exist, it may be impossible to record any images at all. Or there may be no 3D effect, or the image may be distorted even if a picture is recorded.
 - When the subject is too dark or too bright
 - When the subject's brightness changes
 - When the subject is moving
 - When the subject lacks contrast

Registering your own setting combinations

[Custom] Mode

Registering your preferred recording mode, [Rec] menu settings, etc. to [Cust.Set Mem.] and setting the mode dial to **C1** / **C2** allows you to switch quickly to those settings.

[Cust.Set Mem.]

Up to 4 current camera settings can be registered.

■ Recording modes: **A** **P** **A** **S** **M** **C1** **C2** **3D** **SCN** 

1 Select the recording mode you wish to register and set the [Rec] menu, [Motion Picture] menu, [Setup] menu, etc.

2 Select [Cust.Set Mem.] from the [Setup] menu (→51)

3 Use the respective cursor buttons to select custom set for registration and press [MENU/SET]

- A confirmation screen is displayed. Select [Yes] with the respective cursor buttons and then press [MENU/SET].
- The custom settings registered in [C1] can be used with the **C1** of the mode dial. It will be convenient if a custom setting used often is registered, since it can be used by just setting the mode dial.
- The custom settings registered in [C2-1], [C2-2] or [C2-3] can be selected in the **C2** of the mode dial. Up to 3 custom settings can be registered, so select the one matching the needs.

- The self-timer function cannot be stored in custom set.
- Since certain menu items would be reflected in other recording modes, they are not saved.

[Custom]

Settings registered in [Cust.Set Mem.] can be quickly called up by setting the mode dial to **C1** / **C2**.

■ **Recording modes:** **A** **P** **A** **S** **M** **C1** **C2** 3D SCN 

1 Set the mode dial to **C1** / **C2** ([Custom] mode)

- When set to **C1**
→ The camera switches to the recording mode and settings registered in **C1**.
- When set to **C2**
→ Perform steps **2** - **3**

2 Use the respective cursor buttons to select custom set

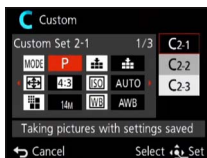

- Use **◀** and **▶** to confirm the registered settings.
- Only the main menu items are displayed.

3 Press [MENU/SET] to enter the settings

The camera switches to the recording mode and settings of the selected custom set.

■ When changing the menu settings

Even if the menu settings are changed temporarily when **C1**, **C2-1**, **C2-2** or **C2-3** is selected for using the custom set, the currently registered settings will remain unchanged.

To change the currently registered settings, overwrite the registered data using [Cust. Set Mem.] (→85) on the [Setup] menu.

■ Changing from one **C2** custom setting to another **C2** custom setting ([Custom] menu)

• To use a custom setting for other than the above case, operate the mode dial.

- ① Press [MENU/SET]
- ② Select [Custom] menu and press [MENU/SET]
- ③ Use **▲** **▼** to select custom set and press [MENU/SET]

■ Recording motion pictures in **C1** / **C2**

Records motion pictures in registered recording mode.







Taking picture series

Recording modes: **A P A S M C1 C2 3D SCN** 

Series of consecutive pictures can be taken by keeping the shutter button fully pressed.

1 Select [Burst] from the [Rec] menu (→51)

2 Use the respective cursor buttons to select the exposure series setting, and press [MENU/SET]



Setting	Frame rate	Description	No. of pictures
 *1	Approx. 2 - 10 pictures/sec.	<ul style="list-style-type: none"> The frame rate is adjusted automatically in accordance with the movements of people, pets or other subjects. ([Intelligent Burst mode]) When a fast-moving subject is recorded, the frame rate becomes faster and the number of pictures that can be recorded in a series is restricted to about 10. 	100*2
	Approx. 2 pictures/sec.	<ul style="list-style-type: none"> The subject is focused as well as it is possible during the intervals between the exposures. The exposure and white balance settings are controlled for every picture in the series. (However, when an exposure series is started during motion picture recording, the focus is fixed to the first picture.) The frame rate may be reduced under certain recording conditions. 	100*2
	Approx. 5 pictures/sec.		
	Approx. 10 pictures/sec.	<ul style="list-style-type: none"> Focus, exposure and White Balance are fixed to the settings for the first picture. 	10
	40 pictures/sec.	<ul style="list-style-type: none"> Focus, exposure and White Balance are fixed to the settings for the first picture. Consider the resolution setting (→88) 	40
	60 pictures/sec.	<ul style="list-style-type: none"> Focus, exposure and White Balance are fixed to the settings for the first picture. The recordable range is reduced. Consider the resolution setting (→88) 	60
 *3	Complies with recording conditions	<ul style="list-style-type: none"> Exposure series can be recorded even in low light conditions as the flash is used. ([Flash Burst]) The focus, exposure, and flash level are all fixed to the settings for the first picture. Consider the resolution setting (→88) 	5
[OFF]	—	The series exposure function is canceled.	—













*1 Only in the **A** mode

*2 The number of serially recorded pictures are limited by the picture-taking conditions and the type and/or status of the card used.

*3 Only in the **P, A, S** modes

■ Possible resolution settings

[Aspect Ratio]			
4:3	5 M, 3 M, 0.3 M	2.5 M, 0.3 M	3 M
3:2	4.5 M, 2.5 M, 0.3 M	3 M, 0.3 M	2.5 M
16:9	3.5 M, 2 M, 0.2 M	3.5 M, 0.2 M	2 M
1:1	3.5 M, 2.5 M, 0.2 M	2 M, 0.2 M	2.5 M

- Pictures taken with the  or  setting are recorded together as a group (exposure series group). (→109)
- Depending on changes in the brightness of the subject, the second and subsequent pictures may be recorded brighter or darker when using the exposure series function at the , , , or  setting.
- The frame rate may be reduced if the shutter speed is reduced in darker locations.
- The pictures taken using the exposure series function at the  or  setting may be distorted if the subjects were moving or the camera was moved.
- [Auto Bracket] is deactivated.
- The flash is set to  [Forced Flash Off]. (However, when  [Flash Burst] is selected, the flash is fixed to  [Forced Flash On].)
- Settings will be stored even if power is turned off.
- The exposure series function cannot be used in the following cases:
 - With [Creative Control] modes ([Toy Effect] [Miniature Effect] [Soft Focus])
 - With Scene Modes ([Panorama Shot] [Handheld Night Shot] [HDR] [High Speed Video])
- When the scene mode is set to [Night Portrait], [Night Scenery] or [High Sens.],  or  cannot be selected.
- When [Selftimer] is set, 3 pictures are taken. (When [Flash Burst] is set, 5 pictures are taken.)
- It may take a while to store still pictures that were taken using the exposure series function.
- Zooming is not possible during an exposure series recording.

Taking pictures with the Face Recognition function

[Face Recog.]

Recording modes: **A P A S M C1 C2 3D SCN** 

- The default [Face Recog.] setting is [OFF].
- When faces are registered, the setting will be [ON] automatically.

■ How the Face Recognition function works

During recording

(When [AF Mode] is  (Face Detection))

- The camera recognizes a registered face and adjusts focus and exposure accordingly.
- When registered faces that have set names are recognized, the names are displayed (up to 3 people).

During playback

- The name and age are displayed (if information is registered).
- The names that have been set for the recognized faces are displayed (up to 3 people).
- Only pictures of the selected registered people are played back ([Category Selection]).

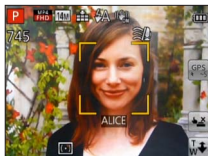

■ Recording tips when registering faces

- Make sure the person's eyes are open and mouth closed; have the person face the camera directly, and make sure the outline of the face, the eyes and eyebrows are not hidden by hair.
- Make sure there are no heavy shadows on the face. (During registration, the flash is not used.)

■ If the camera seems to have difficulty recognizing faces when recording

- Register additional pictures of the same person's face, indoors and outdoors or with different expressions or angles.
 - Register additional pictures at the place you are recording.
 - If a registered person is no longer recognized, re-register that person.
-
- During an exposure series, recording information relating to Face Recognition is based only on the first picture.
 - If you press the shutter release button halfway, then point the camera at a different person and record, recording information for that picture may be based on another person.
 - Face Recognition does not work in the following cases:
 - With [Creative Control] mode ([Miniature Effect] [Soft Focus])
 - With the Scene Modes ([Panorama Shot] [Night Scenery] [Handheld Night Shot] [Food])
 - With motion picture
 - Face Recognition searches for faces similar to those registered, but there is no guarantee it will always recognize these faces. In some cases, the camera cannot recognize or incorrectly recognizes even registered people depending on their expression or the environment.
 - Even if Face Recognition information is registered, pictures recorded when the name is [OFF] are not categorized for Face Recognition in [Category Selection].
 - **Even if Face Recognition information is changed, the Face Recognition information for previously recorded pictures is not changed.**
For example, if a name is changed, pictures recorded before the change are not categorized for Face Recognition in [Category Selection].
 - To change name information for pictures already recorded, perform a [REPLACE] (→125) in [Face Rec Edit].

Registering faces

Up to 6 person's faces can be registered along with such information as name and birthdate.

You can improve the Face Recognition by registering a face more than once. Up to 3 pictures can be utilized to register a face.

- 1** Select [Face Recog.] from the [Rec] menu (→51)
- 2** Select [MEMORY] with the respective cursor buttons and then press [MENU/SET]
- 3** Select [New] with the respective cursor buttons and then press [MENU/SET]
 - If 6 persons are already registered, first delete a registered person. (→91)
- 4** Record the face picture
 - ① Align the face with the guide and record.
 - ② Select [Yes] with the respective cursor buttons and then press [MENU/SET].
 - If re-recording, select [No]
 - Faces of subjects other than persons (e.g. pets) cannot be registered.
 - When the [DISP.] button is pressed, an explanation is displayed.
- 5** Use the respective cursor buttons to select the item for editing and press [MENU/SET]

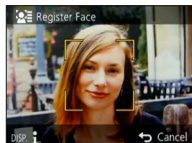

[Name]	<ol style="list-style-type: none"> ① Select [SET] with the respective cursor buttons and then press [MENU/SET] ② Enter the name (Entering text →94)
[Age]	Set the birthdate. <ol style="list-style-type: none"> ① Select [SET] with the respective cursor buttons and then press [MENU/SET] ② Use ◀▶ to select year, month and day, set with ▲▼, and press [MENU/SET]
[Focus Icon]	Change the icon that is displayed when the subject is in focus. <ol style="list-style-type: none"> ① Select the focus icon with the respective cursor buttons and then press [MENU/SET]
[Add Images]	Up to 3 face pictures of the person can be registered. <ol style="list-style-type: none"> ① Select an unregistered frame and press [MENU/SET] <ul style="list-style-type: none"> • When a registered face picture is selected with the respective cursor buttons, a screen to confirm deletion is displayed. Select [Yes] to delete the face picture. (If only one picture is registered, it cannot be deleted.) ② Record the picture (Step 4 above.) ③ Press [📷 / 🔄] button

Editing or deleting information about registered persons

Information about registered people can be edited or deleted.

- 1** Select **[Face Recog.]** in the **[Rec]** menu (→51)
- 2** Select **[MEMORY]** with the respective cursor buttons and then press **[MENU/SET]**
- 3** Use the respective cursor buttons to select the face to be edited or deleted
- 4** Use the respective cursor buttons to select the item and press **[MENU/SET]**

[Info Edit]	For editing a name or other registered information. (→90)
[Priority]	For setting the priority order for focus and exposure. ① Select the registration order with the respective cursor buttons and then press [MENU/SET]
[Delete]	For deleting information and faces of registered persons.

Useful features for travel

[Travel Date]

- For [Setup] menu setting procedures (→51)

If you set your travel schedule and take pictures, the day of your trip on which they were taken will be registered.

■ **Recording modes:**

* Recording only. (Cannot be set.)

- 1** Select [Travel Date] in the [Setup] menu (→51)
- 2** Use the respective cursor buttons to select [Travel Setup] and press [MENU/SET]
- 3** Use the respective cursor buttons to select [SET] and press [MENU/SET]
- 4** Use the respective cursor buttons to select the departure date and press [MENU/SET]
- 5** Use the respective cursor buttons to select the return date and press [MENU/SET]

■ To register [Location]

Once the [Travel Setup] is set, you can set the location.

- ① Select [Location] in step **2** above
 - ② Use the respective cursor buttons to select [SET] and press [MENU/SET]
 - ③ Enter your location (Entering text →94)
- The travel date is calculated from the set departure date and the date set on the camera's clock. When destination is set in [World Time], the days elapsed are calculated based on local destination time.
 - When [Travel Setup] is set to [OFF], the number of days elapsed is not registered. It is not displayed even if [Travel Setup] is set to [SET] after registering.
 - If settings are made before departure date, the number of days to departure are not registered.
 - The [Location] is recorded separately from the location name information which is registered on the pictures by the GPS function.
 - To print [Location] or the number of days that have passed, use [Text Stamp].
 - [Travel Date] cannot be set for AVCHD motion pictures recorded when [Rec Quality] is set to [PSH], [FSH] or [SH].

[World Time]

- For [Setup] menu setting procedures (→51)

Set the recording date and time with the local time at your destination.

■ **Recording modes:** [A] [P] [A] [S] [M] [C1] [C2] [3D] [SON] [🔊]

■ **Preparation:** Set [Auto Clock Set] to [OFF]. (→139)

1 Select [World Time] from the [Setup] menu (→51)

- A message will be displayed when setting for the first time. In this case, press [MENU/SET] and skip to step 3.

2 Use the respective cursor buttons to select [Home] or [Destination] and press [MENU/SET]

3 Use the respective cursor buttons to select area and press [MENU/SET]



When [Destination] has been selected

■ To set summer time

Press ▲ in step 3. (Press again to cancel the setting)

- When summer time is set, the current time is advanced by 1 hour. If the setting is canceled, the time automatically returns to the current time.
- If you cannot find your destination in the area displayed on the screen, set it based on the difference to the home time.
- 🛩️ is displayed on the screen for pictures recorded at the destination when they are played back.
- When [Auto Clock Set] is set to [ON], only the summer time setting of [Destination] can be changed.

Entering Text

Use the respective cursor buttons to enter names with the Face Recognition function and in Scene Modes [Baby] and [Pet], or to register locations in [Travel Date] etc.

1 Use the respective cursor buttons to select characters

2 Press [MENU/SET] several times until the desired character is displayed

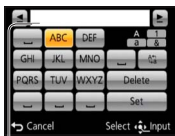



The text is inserted at the cursor position.

- To change the character type
→ Select , and press [MENU/SET].

Cursor position

■ Editing text

- ① Use the respective cursor buttons to select   and press [MENU/SET]. Then, move the cursor to the text to edit
 - You can also use the zoom lever to reposition the cursor.
- ② Use the respective cursor buttons to select [Delete], and then press [MENU/SET]
- ③ Use the respective cursor buttons to select the correct text, and then press [MENU/SET]

3 When you are finished entering text, use the respective cursor buttons to select [Set] and press [MENU/SET]

- A maximum of 30 characters can be entered. (A maximum of 9 characters for [Face Recog.] names)

Using the [Rec] menu

[Aspect Ratio]

- For [Rec] menu setting procedures (→51)

The aspect ratio of still picture can be changed according to printing or playback format.

■ **Recording modes:** **A** **P** **A** **S** **M** **C1** **C2** 3D **SCN**

■ **Settings:** **4:3** / **3:2** / **16:9** / **1:1**

- The edges may be cut off when printing – be sure to check in advance.

[Picture Size]

- For [Rec] menu setting procedures (→51)

Set the resolution (number of pixels) for the pictures. The number of pictures which can be recorded depends on this setting and on [Quality].

■ **Recording modes:** **A** **P** **A** **S** **M** **C1** **C2** 3D **SCN**

■ **Settings:**

Resolution ([Aspect Ratio]: 4:3)					
14 M 4320×3240	10 M * 3648×2736	7 M * 3072×2304	5 M 2560×1920	3 M * 2048×1536	0.3 M 640×480
Resolution ([Aspect Ratio]: 3:2)					
12.5 M 4320×2880	9 M * 3648×2432	6 M * 3072×2048	4.5 M * 2560×1712	2.5 M * 2048×1360	0.3 M * 640×424
Resolution ([Aspect Ratio]: 16:9)					
10.5 M 4320×2432	7.5 M * 3648×2056	5.5 M * 3072×1728	3.5 M * 2560×1440	2 M * 1920×1080	0.2 M * 640×360
Resolution ([Aspect Ratio]: 1:1)					
10.5 M 3232×3232	7.5 M * 2736×2736	5.5 M * 2304×2304	3.5 M * 1920×1920	2.5 M * 1536×1536	0.2 M * 480×480

* This setting is not available in **A** ([Snapshot Mode]).

- A mosaic effect may appear depending on the subject and recording conditions.

Setting guide

Higher resolution	←→	Lower resolution
Crisper picture		Coarser picture
Lower recording capacity		Higher recording capacity

[Quality]

• For [Rec] menu setting procedures (→51)

For setting the quality of picture.

■ **Recording modes:** **A P A S M C1 C2 3D SCN** 

■ **Settings:**  ((Fine)) High quality, priority to picture quality

 ((Standard)) Standard quality, priority to the number of pictures

● The setting is fixed to  in [High Sens.] Scene Mode.

● When [3D Photo Mode] is selected, the displayed icons are different:

 (([3D+Fine])): An MPO picture and a high quality JPEG picture are recorded simultaneously.

 (([3D+Standard])): An MPO picture and a standard quality JPEG picture are recorded simultaneously.

[Sensitivity]

• For [Rec] menu setting procedures (→51)

For setting ISO Sensitivity (sensitivity to lighting) manually.

We recommend higher settings to take better pictures in darker locations.

■ **Recording modes:** **A P A S M C1 C2 3D SCN** 

■ **Settings:** **[AUTO] / [ISO] [Intelligent ISO] / [100] / [200] / [400] / [800] / [1600] / [3200]**

Setting guide

[Sensitivity]	[100] ←→ [3200]
Location (recommended)	Bright (outdoors) Dark
Shutter speed	Slow Fast
Interference	Low High
Subject blur	High Low

● [AUTO] is automatically set in a range up to 800 (1600 when flash is used) based on subject brightness.

● **[ISO]** [Intelligent ISO] is automatically set in a range up to 1600 based on subject movement and brightness.

● The [Sensitivity] is automatically set in the following cases:

- When recording motion pictures
- When [Burst] is set to [Flash Burst]

[White Balance]

- For [Rec] menu setting procedures (→51)

Adjust the coloring to suit the light source if colors otherwise appear unnatural.

■ **Recording modes:**

■ **Settings:** [AWB] (automatic) / (outdoor, clear sky) / (outdoor, cloudy sky) / (outdoor, shade) / (Incandescent lighting) / (uses value set in SET) / SET (set manually)

- When [AWB] (Automatic White Balance) is set, the coloring is adjusted in accordance with the light source. However, if the scene is too bright or too dark or if other extreme conditions apply, the pictures may appear reddish or bluish. The White Balance may not operate correctly if there are multiple light sources.
- Under fluorescent lighting, LED lighting fixture etc., the appropriate White Balance will vary depending on the lighting type, so use [AWB] or SET.
- White Balance setting is fixed to [AWB] in the following cases:
Scene Modes ([Scenery], [Night Portrait], [Night Scenery], [Handheld Night Shot], [Food], [Sunset])
- Even if the camera's power is OFF, the set White Balance is remembered. (If the Scene Mode is changed, the white balance setting returns automatically to [AWB].)

■ White Balance fine adjustment (excluding [AWB])

White Balance settings can be individually fine-tuned if colors still do not appear as anticipated.

- ① Select the white balance to be fine-tuned, and press the [DISP.] button to display the [WB Adjust.] screen
- ② Adjust with if reds are strong, adjust with if blues are strong
- ③ Press [MENU/SET]
 - Settings are remembered even if power is turned off.
 - Settings remain applied when using flash.
 - Fine adjustments cannot be made when [Color Mode] (→103) is set to [B&W] or [SEPIA].

■ Setting White Balance manually (SET)

① Select  SET and press [MENU/SET]

② Point the camera at a white object (e.g. paper) and press [MENU/SET]

White Balance is set to .

- Even if the camera's power is OFF, the White Balance setting is remembered.
- It may not be possible to set the correct White Balance if subjects are too bright or too dark. In this case, adjust the brightness and try to set the White Balance again.

■ [AWB] operational range:

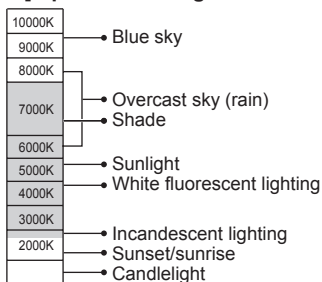

[AF Mode]













- For [Rec] menu setting procedures (→51)

The focus setting mode can be changed according to position and number of subjects.











■ **Recording modes:**

■ **Settings:** / / / /

<p>Taking front-on pictures of persons</p> <p> (Face Detection)</p>	<p>Recognizes faces (up to 15 persons) and adjusts exposure and focus accordingly.</p> <p> AF area Yellow: When the shutter release button is pressed halfway, the frame turns green when the camera is focused. White: Displayed when more than one face is detected. Other faces that are the same distance away as faces within the yellow AF area are also focused.</p>
<p>For automatically locking the focus on a moving subject</p> <p> (AF Tracking)</p>	<p>Touch the subject</p> <p> AF Tracking frame When the subject is recognized, the AF tracking frame changes from white to yellow, and the subject is automatically kept in focus. If AF Lock fails, a red frame flashes.</p> <ul style="list-style-type: none"> • Perform these operations with the touch shutter function (→29) activated. • To deactivate AF tracking → Touch . • About focus range (same as macro recording) (→68) • You can also use to perform this function.
<p>Subject not centered in picture</p> <p> (23-area-focusing)</p>	<p>Focuses on up to 23 points.</p>
<p>Determined position for focusing</p> <p> (1-area-focusing) (Spot-focusing)</p>	<p>1-area-focusing: Focuses on AF area in the center of the picture. (Recommended when focusing is difficult) Spot-focusing: Focuses on a smaller, limited area.</p>

- Focus is fixed to  (1-area-focusing) in the following cases:
 - [High Speed Video] scene mode
 - [Miniature Effect] in [Creative Control] mode
- Use  (1-area-focusing) if focusing is difficult with  (Spot-focusing).
-  (Face Detection) cannot be set the following cases:
 - Scene Modes ([Panorama Shot] [Night Scenery] [Handheld Night Shot] [Food])
 - [Creative Control] Mode ([Soft Focus])
- If the camera misinterprets a non-human subject as a face in  (Face Detection) setting, switch to another setting.
- If conditions prevent the face from being recognized, such as when the movement of the subject is too rapid, the [AF Mode] setting switches to  (23-area-focusing).
- Under certain recording conditions, such as when the subject is small or dark,  (AF Tracking) may not operate correctly.
When  (AF Tracking) does not work, focusing will be set to  (23-area-focusing).
- Cannot set to  (AF Tracking) in the following cases.
 - [Panorama Shot] Scene Mode
 - [B&W] and [SEPIA] in [Color Mode]
 - [Creative Control] Mode ([Sepia] [Dynamic Monochrome] [High Dynamic] [Toy Effect] [Soft Focus])
- When  (23-area-focusing) or  (Spot-focusing) is set, the [AF Mode] setting at the time of motion picture recording switches to  (1-area-focusing).

[Quick AF]

- For [Rec] menu setting procedures (→51)
Focusing is performed automatically when camera blurring is small even when the shutter release button is not pressed. (Increases battery consumption)
- **Recording modes:**          
- **Settings:** [ON] / [OFF]
- Focusing may take time in case of zooming from maximum wide to maximum tele setting, or if the distance to the subject is suddenly reduced.
- Press the shutter release button if the distance to the subject is suddenly reduced.
- This function will turn [OFF] in the following cases.
[Night Portrait], [Night Scenery], [Handheld Night Shot] and [High Speed Video] Scene Modes
- [Quick AF] will not work while AF Tracking is operating.

[Face Recog.]



- For [Rec] menu setting procedures (→51)
For details (→89).

[Metering Mode]

- For [Rec] menu setting procedures (→51)
This function allows adapting the metering mode to different subjects and situations.

■ Recording modes: **A P A S M C1 C2 3D SCN** 

■ Settings:

[Metering Mode]	Metering characteristics	Conditions
 [Multi Metering]	The brightness is detected in different sections of the frame. The exposure is then based on the probable main subject	Normal usage (high probability of automatically correctly exposed main subjects even with greater brightness differences)
 [Center Weighted]	The metering sensitivity is concentrated on the center while also registering the rest of the frame	Use when subject is in the center, or to deliberately base the exposure on an off-center subject (provided, subject is of medium brightness)
 [Spot]	Only a small area in the center is registered	Use to base the exposure on very small subject parts (provided, these parts are of medium brightness)

[i.Exposure]

- For [Rec] menu setting procedures (→51)
Automatically adjusts contrast and exposure to give more lifelike colors when there is significant contrast between background and subject.

■ Recording modes: **A P A S M C1 C2 3D SCN** 

■ Settings:  [LOW] /  [STANDARD] /  [HIGH] / [OFF]

- [LOW], [STANDARD] and [HIGH] indicate the maximum range of correction.
- When [i.Exposure] works, the color of  changes.
- Even if [Sensitivity] is set to [100], when [i.Exposure] is activated, pictures may be taken at a higher ISO Sensitivity than the setting.

[Min. Shtr Speed]

- For [Rec] menu setting procedures (→51)

Allows extending the shutter speed range for automatic exposure control modes. We recommend using slower shutter speeds to take brighter pictures in dark locations.

■ **Recording modes:** **A** **P** **A** **S** **M** **C1** **C2** 3D SCN 

■ **Settings:** [AUTO] [1/250] [1/125] [1/60] [1/30] [1/15] [1/8] [1/4] [1/2] [1]

- Slower shutter speeds allow for brighter pictures but increase the risk of camera shake, so we recommend using a tripod and the self-timer.
- As still pictures may become dark when using faster speeds such as [1/250], we recommend that still pictures are taken in bright locations (**MIN** flashes red when the shutter release button is pressed halfway if the picture will be dark).
- **MIN** is displayed on screen for settings other than [AUTO].

[i.Resolution]

- For [Rec] menu setting procedures (→51)

You can use the camera's Intelligent Resolution technology to record still pictures with sharper outlines and clearer resolution. Also, when [i.ZOOM] is set, the zoom ratio can be increased two times higher than the original zoom ratio with limited deterioration of picture quality.

■ **Recording modes:** **A** **P** **A** **S** **M** **C1** **C2** 3D SCN 

■ **Settings:** [ON] / [i.ZOOM] / [OFF]

- About [i.ZOOM] (→65)

[Digital Zoom]

- For [Rec] menu setting procedures (→51)

Zoom 4 times further than Optical/Extra optical zoom. (Note that enlarging will decrease picture quality with Digital Zoom.)

■ **Recording modes:** **A** **P** **A** **S** **M** **C1** **C2** 3D SCN 

■ **Settings:** [ON] / [OFF]

- This mode is fixed to [ON] when [Macro Zoom] is set.
- When Digital Zoom is used simultaneously with i.Zoom, you can only increase the zoom ratio up to 2 times.

[Burst]

- For [Rec] menu setting procedures (→51)
For details (→87).

[Color Mode]

- For [Rec] menu setting procedures (→51)
For setting color effects.

■ **Recording modes:** **A P A S M C1 C2 3D SCN** 

■ **Settings:** **[STANDARD]** / **[VIVID]*1** (sharper) / **[B&W]** / **[SEPIA]** / **[Happy]*2**

*1 Except [Snapshot Mode]

*2 [Snapshot Mode] only

[AF Assist Lamp]

- For [Rec] menu setting procedures (→51)
Switches on the lamp to facilitate focusing in dark conditions.

■ **Recording modes:** **A P A S M C1 C2 3D SCN** 

■ **Settings:** **[ON]** : Lamp illuminated with halfway press of the shutter release button

[OFF] : Lamp off (for taking pictures of animals in the dark, etc.)

- The AF Assist Lamp has an effective distance of 1.5 m (4.9 feet).
 - Do not cover the lamp with your fingers or look at it from close range.
- The setting is fixed to [OFF] in the following Scene Modes:
[Scenery] [Night Scenery] [Handheld Night Shot] [Sunset]
[Through window] [High Speed Video]

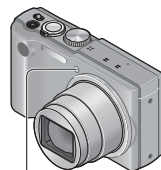

AF Assist Lamp



[Red-Eye Removal]

- For [Rec] menu setting procedures (→51)

This mode automatically detects the red-eye effect and corrects still picture data when recording with flash red-eye reduction (ⓂAⓂ ⓂSⓂ).

■ **Recording modes:** A P A S M C1 C2 3D SCN 

■ **Settings:** [ON] / [OFF]

- This mode setting will work only when [AF Mode] is set to  (Face Detection).
- Depending on the circumstances, it may not be possible to correct the red-eye effect.
- When the function setting is [ON],  appears with the flash icon.

[Stabilizer]

- For [Rec] menu setting procedures (→51)

This mode automatically detects and prevents camera shake.

When recording motion pictures, [Active Mode] (stabilizer for motion pictures) will automatically function. This decreases the camera shake effect while walking, etc.

■ **Recording modes:** A P A S M C1 C2 3D SCN 

■ **Settings:** [ON] / [OFF]

- The setting is fixed to [ON] in [Handheld Night Shot] Scene Mode.
- The setting is fixed to [OFF] in the following Scene Modes:
 - [Panorama Shot] Scene Mode
 - [High Speed Video] Scene Mode
- Cases where Optical Image Stabilizer may be ineffective: Heavy camera shake, high zoom ratios (also in the Digital Zoom range), fast-moving objects, indoors or in dark locations (due to low shutter speed)
- In [Active Mode], a stronger compensation effect can be achieved with shorter focal lengths (wideangle).
- In the following case, [Active Mode] will not function even when recording motion pictures.
 - When the recording mode is set to [VGA] in [MP4].

[Date Stamp]

- For [Rec] menu setting procedures (→51)

Still pictures can be taken with the recording date and time stamped on the still picture.

■ **Recording modes:**          

■ **Settings:** [W/O TIME] / [WITH TIME] / [OFF]

- Date stamps on still pictures cannot be erased.
- The date cannot be stamped when [Auto Bracket] or [Burst] is set, when recording a motion picture, or when the [Panorama Shot] or [High Speed Video] Scene Modes are set.
- Do not request date printing in a store or make date printing on a printer for still pictures with date stamps. (Date printing may be overlapping.)
- The setting cannot be changed in [Snapshot Mode]. The setting in other Recording Modes is applied.

[Clock Set]

- For [Rec] menu setting procedures (→51)

For setting the clock. Same function as that in [Setup] menu.

Using the [Motion Picture] menu

[Rec Mode]

- For [Motion Picture] menu setting procedures (→51)
For setting the data format of the motion picture that is recorded.

■ **Recording modes:**       3D  

■ **Settings:**

[AVCHD]	• This is a data format suitable for playback on high-definition TVs.
[MP4]	• This data format is suited for playing back motion pictures on a computer and other such devices.

- For details (→38)

[Rec Quality]

• For [Motion Picture] menu setting procedures (→51)
For setting the resolution of the motion picture that is recorded.

■ Recording modes: **[A] [P] [AS] [M] [C1] [C2] 3D [SCN] [G]**

■ Settings:

[AVCHD] in [Rec Mode]

Item	Resolution/Bit rate	fps	[Aspect Ratio]
[GPH]	1920×1080 pixels/Approx. 28 Mbps	60p*2 / 50p*3	16:9
[PSH]*1			
[GFS]	1920×1080 pixels/Approx. 17 Mbps	60i*2 / 50i*3	
[FSH]*1			
[GS]	1280×720 pixels/Approx. 17 Mbps	60p*2 / 50p*3	
[SH]*1			

*1 The positioning location and place name information are not recorded.

[MP4] in [Rec Mode]

Item	Resolution/Bit rate	fps	[Aspect Ratio]
[FHD]	1920×1080 pixels/Approx. 20 Mbps	30*2 / 25*3	16:9
[HD]	1280×720 pixels/Approx. 10 Mbps		
[VGA]	640×480 pixels/Approx. 4 Mbps		4:3

*2 With camera models 18 176 / 18 177

*3 With camera model 18 175

● What is a bit rate

This is the volume of data for a defined period of time, and the quality becomes higher when the number gets bigger. This unit uses the “VBR” recording method. “VBR” is an abbreviation of “Variable Bit Rate”, and the bit rate (volume of data for a defined period of time) is changed automatically depending on the subject being recorded. Therefore, the recording time is shortened when a subject with fast movement is recorded.

- Motion pictures recorded using [High Speed Video] Scene Mode are recorded in Motion JPEG with a resolution of QVGA (320×240 pixels).

[Continuous AF]

- For [Motion Picture] menu setting procedures (→51)

This mode allows either constant focusing during motion picture recording, or determining the focus setting at the start of recording.

■ **Recording modes:** 3D

■ **Settings:** [ON]

[OFF]: Determines the focusing setting at the start of motion picture recording.

[Wind Cut]

- For [Motion Picture] menu setting procedures (→51)



This mode automatically detects wind sounds (wind noise) captured by the microphone and suppresses the sound if the wind is blowing too strongly.

■ **Recording modes:** 3D

■ **Settings:** [AUTO] / [OFF]

- When [Wind Cut] is set to [AUTO], the sound quality may differ from that of normal recordings.
- The setting is fixed to [OFF] in the following cases:
 - [Miniature Effect] of the [Creative Control] Mode
 - [High Speed Video] scene mode

Playing back still pictures recorded using the serial exposure function

Pictures taken with the  or  setting are recorded together as a group (serial exposure group).

■ Representative picture display

A representative picture (first picture of the series) is displayed when it is displayed together with other still pictures or with motion pictures.



- All the pictures in a serial exposure group can be deleted or edited together.
- Continuous playback can be performed using the same operations as for motion pictures. (→45)

■ Display within each serial exposure group

Still pictures recorded in a single serial exposure group can be displayed separately or as a list.

1 Touch

The display within each serial exposure group appears on the screen.



On the display within each serial exposure group, only the serial exposure picture groups are displayed.

- To return to the representative screen display
→ Touch .

■ Re-acquiring the serial exposure group information

When the power is turned on, the  (acquiring information icon) may appear.

While  is displayed, pictures cannot be deleted and the [Playback] menu cannot be used. Only [Normal Play] or [Calendar] is available as the [Playback Mode].

Playing back still pictures recorded using the serial exposure function

- [Playback] menu items cannot be used while the display appears within each serial exposure group.
- Serial exposure picture cannot be displayed as a group during [GPS Area Play] or [Favorite] playback with [Slide Show] or [Filtering Play].
- [Cropping] cannot be performed together for all the pictures in a serial exposure group.
- Serial exposure recorded after the total number of pictures has exceeded 50,000 will not be grouped.
If only one picture is left over in a serial exposure group after deletion or other operations, it will not be formed into a group, either.
- The serial exposure recorded by another device may not be recognized as a serial exposure group.
- Serial exposure will not be grouped if recorded without setting the clock.

Different playback methods

[Playback Mode]

Recorded pictures can be played back in a variety of ways.

1 Press [MENU/SET] in playback mode

The menu selection screen is displayed.

2 Use the respective cursor buttons to select [Playback Mode] menu and press [MENU/SET]



• The menu type can also be selected by touch operations.

3 Use the respective cursor buttons to select the playback method and press [MENU/SET]

- [Normal Play] (→42)
- [2D/3D Settings] (→160)
- [Slide Show] (→112)
- [Filtering Play] (→114)
- [Calendar] (→114)

- When no card is inserted, pictures are played back from the built-in memory.
- The [Playback Mode] automatically becomes [Normal Play] when the REC/PLAY switch is set to  and the power is turned on, or when switching from recording mode to playback mode.

[2D/3D Settings]

- For switching [Playback Mode] (above)

The playback method for the 3D pictures can be switched. This menu is only displayed during HDMI output. For the procedure for playing back a 3D still picture (→159).

[Slide Show]

- For switching [Playback Mode] (→111)

For automatically playing back pictures in a certain order and to music. Recommended when viewing on TV screen.

1 Use the respective cursor buttons to select the playback method and press [MENU/SET]

[All]	Plays back all pictures.
[Picture Only]	Plays back still pictures.
[Motion Pic. Only]	Plays back motion pictures.
[3D Play]	Plays back only 3D still pictures that were recorded in [3D Photo Mode].
[GPS Area Play]	For selecting place name or landmark to play back pictures recorded in the same place. (Use the respective cursor buttons to select the place name or the landmark and then press [MENU/SET].)
[Travel]	Plays back only pictures that were recorded with the [Travel Setup] or [Location]. (→114)
[Category Selection]	For selecting category and playing back motion or still pictures. (Select category with the respective cursor buttons and press [MENU/SET].) (→114)
[Favorite]	Plays back the pictures set as [Favorite]. (→122)

2 Use the respective cursor buttons to set playback effects and press [MENU/SET]

[Effect] (For selecting music and effects according to the picture atmosphere)	
[AUTO] (only available with [Category Selection] setting) / [NATURAL] / [SLOW] / [SWING] / [URBAN] / [OFF]*	
[Setup]	
[Duration]	[1SEC] / [2SEC] / [3SEC] / [5SEC] (Only available when [Effect] is [OFF])
[Repeat]	[ON] / [OFF]
[Sound]	[OFF]: Music and audio will not play back. [AUTO]: With still pictures, music will play back, and with motion pictures, audio will play back. [Music]: Music effect will play back. [Audio]: Audio is played back from motion pictures.

* In the following case, [Effect] is fixed to [OFF].

- [Motion Pic. Only]
- [Burst] of [Category Selection]

3 Select [Start] with the respective cursor buttons and press [MENU/SET]

■ Operations during Slide Show

The operation guide appears on the bottom right of the monitor.

- If you do not perform any operation for approx. 2 seconds, the operation guide is turned off. To display the guide again, press the [DISP.] button.

During motion picture/
serial exposure group/
panorama picture playback

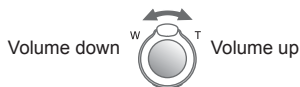
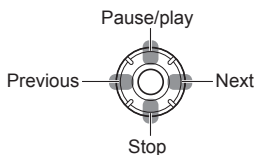

During still picture playback

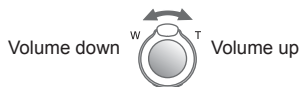
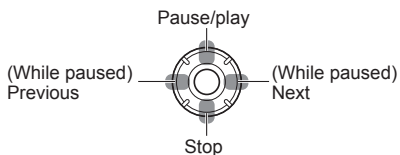

- When [URBAN] has been selected, the picture may appear in black and white as a screen effect.
- When panorama pictures are played back, the [Duration] setting is disabled.
- Part of [Effect] cannot be used when displaying pictures on television using the HDMI mini cable (available as accessory →9) or when displaying pictures recorded in portrait format.
- Music effects cannot be added.

[Filtering Play]

- For switching [Playback Mode] (→111)

You can refine the selection of pictures to be viewed by narrowing them down to pictures in selected categories or to favorite pictures, and then view those pictures.

1 Select the filtering method using the respective cursor buttons, and press [MENU/SET]

[Picture Only]	Plays back still pictures																		
[Video Only]	Plays back motion pictures																		
[3D Play]	Plays back only 3D still pictures that were recorded in [3D Photo Mode].																		
[GPS Area Play]	For selecting the location name of the place where the pictures were taken or the landmark name, and playing the pictures back. ① Select the region whose pictures are to be played back using the respective cursor buttons, and press [MENU/SET]. ② Select the location name or landmark name using the respective cursor buttons, and press [MENU/SET].																		
[Travel]	Plays back pictures with [Travel Date] that have been set at the time of their recording. ① Select whether to play back the pictures by date or by travel location using the respective cursor buttons, and press [MENU/SET]. • When [All] is selected, the pictures recorded with [Travel Date] are played back. ② Select the date or travel location using the respective cursor buttons, and press [MENU/SET].																		
[Category Selection]	Plays back pictures that have been narrowed down by category, such as Scene Mode. ① Select the category using the respective cursor buttons, and press [MENU/SET].																		
	<table border="1"> <tr> <td></td> <td>Pictures taken using Face Recognition</td> </tr> <tr> <td></td> <td>[Portrait] / [Soft Skin] / [Night Portrait] / [Baby] / </td> </tr> <tr> <td></td> <td>[Scenery] / [Panorama Shot] / [Sunset] / [Through window]</td> </tr> <tr> <td></td> <td>[Night Portrait] / [Night Scenery] / [Handheld Night Shot] / </td> </tr> <tr> <td></td> <td>[Sports]</td> </tr> <tr> <td></td> <td>[Baby] / </td> </tr> <tr> <td></td> <td>[Pet]</td> </tr> <tr> <td></td> <td>[Food]</td> </tr> <tr> <td></td> <td>[Burst] (or only)</td> </tr> </table>		Pictures taken using Face Recognition		[Portrait] / [Soft Skin] / [Night Portrait] / [Baby] /		[Scenery] / [Panorama Shot] / [Sunset] / [Through window]		[Night Portrait] / [Night Scenery] / [Handheld Night Shot] /		[Sports]		[Baby] /		[Pet]		[Food]		[Burst] (or only)
	Pictures taken using Face Recognition																		
	[Portrait] / [Soft Skin] / [Night Portrait] / [Baby] /																		
	[Scenery] / [Panorama Shot] / [Sunset] / [Through window]																		
	[Night Portrait] / [Night Scenery] / [Handheld Night Shot] /																		
	[Sports]																		
	[Baby] /																		
	[Pet]																		
	[Food]																		
	[Burst] (or only)																		
[Favorite]	Plays back pictures set as [Favorite]. (→122)																		

[Calendar]

- For switching [Playback Mode] (→111)

For selecting the date from the calendar screen to view only the pictures taken on that day. (→44)

Retouching pictures

[Auto Retouch]

With this mode, you can adjust the color and brightness of a still picture to bring them into balance.

- New pictures are created after editing pictures with [Auto Retouch]. Before starting to edit, make sure that there is enough free space in the built-in memory or the memory card.



• Example picture

1 Select a still picture to retouch during playback and press **▲**

2 Use the respective cursor buttons to select [Auto Retouch] and press [MENU/SET]

3 Use the respective cursor buttons to select [ON] and press [MENU/SET]

- A confirmation screen is displayed. If you select [Yes], the new retouched still picture is saved.
- When [OFF] is selected, you can restore a picture to its original condition (before retouching).

- The retouch effect may be less apparent in some still pictures.
- Some still pictures may have higher noise levels after retouching.
- It may not be possible to use [Auto Retouch] with still pictures that have already been retouched.
- It may not be possible to retouch still pictures recorded with other cameras.
- You cannot retouch the pictures in a serial exposure group together as a group. Retouch each picture in a serial exposure group after displaying it.
- [Auto Retouch] is not available in the following cases:
 - Motion pictures
 - Still pictures recorded in [Panorama Shot] Scene Mode
 - 3D still pictures

[Creative Retouch]

With this mode, you can retouch recorded still pictures by selecting the effect that you want to apply.

- New pictures are created after editing pictures with [Creative Retouch]. Before starting to edit, make sure that there is enough free space in the built-in memory or the memory card.

1 Select a still picture to retouch during playback and press ▲

2 Use the respective cursor buttons to select [Creative Retouch] and press [MENU/SET]

3 Press ▲ ▼ to select a setting

- The picture retouched with the selected effect is displayed.
- When [OFF] is selected, you can restore a picture to its original condition (before retouching).

Setting	Effect
[EXPS] [Expressive]	This picture effect creates a pop art style picture that enhances the color.
[RETR] [Retro]	This picture effect creates the soft appearance of a tarnished picture.
[HKEY] [High Key]	This picture effect creates a brighter and lighter toned appearance for the entire picture.
[MONO] [Dynamic Monochrome]	This picture effect creates a monochromatic picture with a higher contrast and more dramatic atmosphere.
[TOY] [Toy Effect]	This picture effect creates a picture that resembles those taken by a toy camera with a reduced amount of peripheral light. <ul style="list-style-type: none"> • About adjusting color hue → Press the [DISP.] button and use the respective cursor buttons to select the color hues.
[SOFT] [Soft Focus]	This picture effect creates a soft appearance by intentionally blurring the entire picture.

4 Press [MENU/SET]

- A confirmation screen is displayed. If you select [Yes], the new retouched still picture is saved.

- The retouch effect may be less apparent in some still pictures.
- It may not be possible to retouch still pictures recorded with other cameras.
- You cannot retouch the pictures in a serial exposure group together as a group. Retouch each picture in a serial exposure group after displaying it.
- [Creative Retouch] is not available in the following cases:
 - Motion pictures
 - Still pictures recorded in [Panorama Shot] Scene Mode
 - 3D still pictures

Using the [Playback] menu

With this mode, you can edit a selected picture (e.g. trim it), mark it as protected, a.s.o..

- For [Playback] menu display and operation methods (→51)
- Depending on the [Playback Mode], some [Playback] menu items are not displayed.
- It may not be possible to set or edit pictures taken with other cameras.
- New pictures are created after editing pictures with tools such as [Text Stamp], [Resize] and [Cropping]. Before starting to edit, make sure that there is enough free space in the built-in memory or the memory card.

[Title Edit]

- For [Playback] menu display and operation methods (→51).

With this mode, you can give titles, etc. to your favorite still pictures.

1 Use the respective cursor buttons to select [SINGLE] or [MULTI], and then press [MENU/SET]

2 Select a still picture

- [SINGLE]

Use the respective cursor buttons to select a still picture and press [MENU/SET]



- [MULTI]

(up to 100 pictures with the same text)

Use the respective cursor buttons to select a still picture and press [DISP.] button

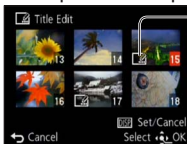

[Title Edit] setting

[Title Edit] already set

- To cancel
→ Press [DISP.] button again.
- To execute
→ Press [MENU/SET].

3 Enter characters (Entering text (→94))

To delete a title, delete all the characters in the character input screen.

- This mode is not available in the following cases:
 - Motion pictures
 - 3D still pictures
- To print text, use [Text Stamp].

[Edit GPS Data]

For details (→138).

[Text Stamp]

- For [Playback] menu display and operation methods (→51).

With this mode, the recording date and time, location name information and the text registered in the [Baby], [Pet] Scene Modes, [Travel Date] and [Title Edit] can be stamped on the still picture.

1 Use the respective cursor buttons to select [SINGLE] or [MULTI], and then press [MENU/SET]

2 Select a still picture

● [SINGLE]

Use the respective cursor buttons to select a still picture and press [MENU/SET]



● [MULTI] (up to 100 pictures)

Use the respective cursor buttons to select a still picture and press [DISP.] button

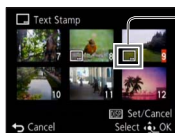

☐ [Text Stamp] setting

- To cancel
→ Press [DISP.] button again.
- To execute
→ Press [MENU/SET].

3 Use the respective cursor buttons to select [Set] and press [MENU/SET]

4 Use the respective cursor buttons to select items and press [MENU/SET] (→119)

5 Use the respective cursor buttons to select settings and press [MENU/SET] (→119)



6 Press [⏪ / ⏩] button

7 Use the respective cursor buttons to select [OK] and press [MENU/SET]

8 Use the respective cursor buttons to select whether to stamp age and press [MENU/SET]

- If [Name] is [OFF] in step 5, this step will not be displayed.
- A confirmation screen is displayed. If you select [Yes], the operation is executed.

■ Items that can be stamped

[Shooting Date]	[W/O TIME]: Stamps the recording date [WITH TIME]: Stamps recording date and time
[Name]	 : Stamps the name registered in Face Recognition  /  : Stamps the name registered in [Baby] or [Pet]
[Location]	Stamps the location registered in [Setup] menu's [Travel Date]
[Travel Date]	Stamps the Travel Date set in [Setup] menu's [Travel Date]
[Title]	Stamps the text registered in [Title Edit]
[Country/Region]	Stamps the place name information recorded by the GPS function • If text such as the location name or landmark name is long, it may not be possible to stamp all the text.
[State/Prov./County]	
[County/Township]	
[City/Town/Village]	
[Landmark]	

- Items set to [OFF] are not stamped.
- Stamping texts is not possible with the following types of pictures.
 - Motion pictures
 - 3D pictures
 - Pictures on which the date or other texts have already been stamped
 - Pictures taken without setting the clock
 - Pictures recorded in [Panorama Shot] Scene Mode
- Characters may be cut off on certain printers.
- The text may be difficult to read when stamped on pictures of 0.3 M or less.
- **Do not request date printing in a store or make date printing on a printer for still pictures with date stamps. (Date printing may be overlapping.)**

[Resize]

- For [Playback] menu display and operation methods (→51).

With this mode, the resolution can be reduced to facilitate e-mail attachment and use in web pages, etc.

(Still pictures recorded at the smallest recording pixel level cannot be further reduced.)

■[SINGLE]

- 1 Use the respective cursor buttons to select [SINGLE] and press [MENU/SET]
- 2 Use the respective cursor buttons to select a still picture and press [MENU/SET]
- 3 Use the respective cursor buttons to select size and press [MENU/SET]

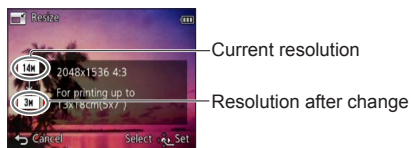

Current resolution

Resolution after change

- A confirmation screen is displayed. If you select [Yes], the operation is executed.

■[MULTI]

- 1 Use the respective cursor buttons to select [MULTI] and press [MENU/SET]
- 2 Use the respective cursor buttons to select size and press [MENU/SET]
- 3 Use the respective cursor buttons to select a still picture and press [DISP.] button (up to 100 pictures)

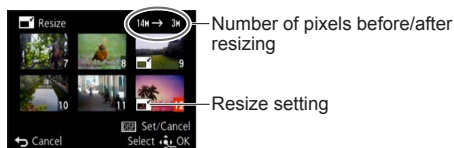

Number of pixels before/after resizing

Resize setting

- To cancel
→ Press [DISP.] button again.
- To execute
→ Press [MENU/SET].

- A confirmation screen is displayed. If you select [Yes], the operation is executed.

- Picture quality is reduced after resizing.
- Resizing is not possible with the following types of pictures.
 - Motion pictures
 - 3D still pictures
 - Still pictures for which date or other texts have already been stamped
 - Still pictures recorded in [Panorama Shot] Scene Mode

[Cropping]

- For [Playback] menu display and operation methods (→51).
For enlarging your still pictures and cropping unwanted areas.

1 Use the respective cursor buttons to select a still picture, and then press [MENU/SET]

2 Select the area to crop and press [MENU/SET]

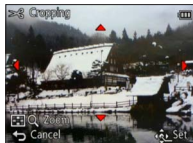

Expand



Change position

- A confirmation screen is displayed. If you select [Yes], the operation is executed.
- Picture quality is reduced after cropping.
- Cropping is not possible with the following types of pictures.
 - Motion pictures
 - Still pictures for which date or other texts have already been stamped
 - Still pictures recorded in [Panorama Shot] Scene Mode
 - 3D still pictures
- Original Face Recognition information will not be copied when still pictures are cropped.

[Favorite]

- For [Playback] menu display and operation methods (→51).

By labelling your favorite pictures with a star (★), you can play back your favorite pictures only, or you can delete all pictures except your favorites.

1 Use the respective cursor buttons to select [SINGLE] or [MULTI] and press [MENU/SET]

2 Use the respective cursor buttons to select picture and press [MENU/SET]

● [SINGLE]



Favorite picture setting

● [MULTI]

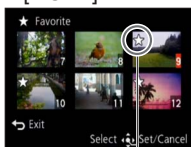

Favorite picture setting

- To cancel → Press [MENU/SET] again.

■ To clear all

Select [CANCEL] in step **1** and select [Yes].

[Print Set]

- For [Playback] menu display and operation methods (→51).

With this mode, picture/picture no./date printing settings can be made for when printing with DPOF print-compatible shops or printers. (Ask at the shop to check for compatibility.)

- 1 Use the respective cursor buttons to select [SINGLE] or [MULTI] and press [MENU/SET]**
- 2 Use the respective cursor buttons to select picture and press [MENU/SET]**
- 3 Use the respective cursor buttons to set number of pictures and press [MENU/SET]**

(repeat steps **2** and **3** when using [MULTI] (up to 999 pictures))

● [SINGLE]

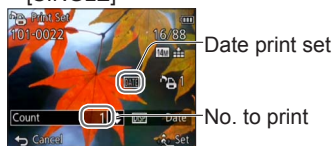

● [MULTI]

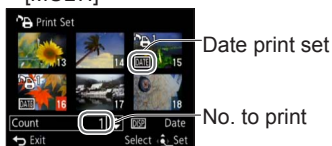

- Date print setting/release → Press [DISP.] button

■ To clear all

Select [CANCEL] in step **1** and select [Yes].

- Depending on the type of printer, the printer settings may take priority over camera settings.
- This setting is not possible for files that are not compliant with the DCF standard.
- Some DPOF information set by other equipment cannot be used. In such cases, delete all of the DPOF information and then set it again with this camera.
- Date print setting cannot be made for still pictures that have been taken with [Date Stamp] and pictures with a [Text Stamp] applied.
- Print settings cannot be applied for motion pictures.

[Protect]

- For [Playback] menu display and operation methods (→51).
For setting protection to disable picture deletion. Prevents deletion of important pictures.

1 Use the respective cursor buttons to select [SINGLE] or [MULTI] and press [MENU/SET]

2 Use the respective cursor buttons to select picture and press [MENU/SET]

● [SINGLE]



Picture is protected

● [MULTI]



Picture is protected

- To cancel → Press [MENU/SET] again.

■ To clear all

Select [CANCEL] in step **1** and select [Yes].

- This setting may not be effective when using other devices.

[Face Rec Edit]

- For [Playback] menu display and operation methods (→51).

For editing or deleting the recognition information for pictures with mistaken Face Recognition.

- 1 Use the respective cursor buttons to select [REPLACE] or [DELETE] and press [MENU/SET]**
- 2 Use the respective cursor buttons to select the picture and press [MENU/SET]**
- 3 Use the respective cursor buttons to select a person and press [MENU/SET]**
 - If [DELETE], go to step **5**.
 - Persons whose faces have not been registered cannot be selected.
- 4 Use the respective cursor buttons to select the person to replace for another and press [MENU/SET]**
- 5 Use the respective cursor buttons to select [Yes] and press [MENU/SET]**

- When Face Recognition information is deleted, it cannot be restored.
- Pictures for which all Face Recognition information has been deleted are not categorized in Face Recognition during [Category Selection].
- Recognition information cannot be edited in protected pictures.

[Copy]

- For [Playback] menu display and operation methods (→51).

With this mode, you can copy pictures between the built-in memory and the memory card.

1 Use the respective cursor buttons to select the copy method (direction) and press [MENU/SET]



Copies all pictures from the built-in memory to the card (go to step 3).



Copies 1 picture at a time from the card to the built-in memory.

2 Use the respective cursor buttons to select picture and press [MENU/SET]

3 Use the respective cursor buttons to select [Yes] and press [MENU/SET]

- To cancel → Press [MENU/SET].

- Copying pictures may take several minutes. Do not turn off power or perform other operations during copying.
- If identical names (folder/file numbers) are present in the copy destination, a new folder for copying will be created when copying from the built-in memory to the card (IN→SD). Identically-named files will not be copied from the card to the built-in memory (SD→IN).
- The following settings are not copied. Set them again after copying.
- [Print Set] - [Protect] - [Favorite]
- Only pictures from Leica digital cameras (exceptions: Digilux, Digilux4.3, Digilux Zoom) may be copied.
- Motion pictures recorded in [AVCHD] format cannot be set.

Using the GPS function to record the picture taking location

Before using the GPS function, read "About GPS" (→8) and "Licence Agreement for Place Name and Map Data" (→188).

GPS stands for Global Positioning System. You can check your current location using GPS satellites. The camera receives radio signals that contain orbital information and time information from multiple GPS satellites, and uses them to calculate its current position. Calculating a position in this manner is known as "positioning".

This camera can record the location information of a place where a picture was taken on the pictures.

The camera can also automatically adjust the time or display a place where a picture was taken on a map during playback.

Precautions on properly receiving a GPS signal

- It is recommended to hold the camera steady with the built-in GPS antenna pointed at the sky while updating the GPS. (→128)
- The camera cannot properly receive radio signals from the GPS satellites in the following places. As a result, it may not be able to execute positioning or a significant error in positioning may occur.
 - Inside buildings
 - Surrounded by trees, such as in a forest
 - Inside a moving train, vehicle, etc.
 - Near high-voltage electrical power lines
 - In building basements
 - Between tall buildings or in a valley
 - Inside tunnels
 - Near devices such as a 1.5 GHz band mobile phone

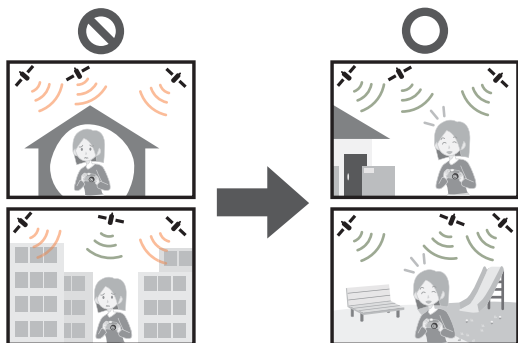

- Do not cover the built-in GPS antenna with your hand or other objects.
- If you want to execute positioning while you carry the camera around, do not put it in a metallic bag or case. If the camera is enclosed in something metallic, it cannot execute positioning.

Using the GPS function to execute positioning

When [GPS Setting] is [ON], the camera periodically receives radio signals from the GPS satellites and executes positioning. When positioning is executed successfully, the place name and position (latitude and longitude) information are recorded in still pictures and motion pictures (except for the picture quality settings of [PSH], [FSH], and [SH]).

- If you select automatic time adjustment using the GPS function when you set the clock of this camera for the first time, [GPS Setting] is set to [ON].

1 Press [MENU/SET]

2 Use the respective cursor buttons to select [GPS] menu and press [MENU/SET]

3 Use the respective cursor buttons to select [GPS Setting] and press [MENU/SET]



4 Use the respective cursor buttons to select [ON] and press [MENU/SET]

- A message appears on the screen. After confirming the message, press [MENU/SET].

[GPS Setting]	Description
[ON]	The camera periodically executes positioning. Even if the camera is turned off, positioning will be continued. (Positioning will stop after a certain period of time has elapsed.)
[OFF]	The GPS function is set to OFF.
[INFO]	You can check the current reception status.

■ About operations during positioning

The GPS status indicator lights up while positioning is being executed and the GPS reception icon appears on the screen. (→129)

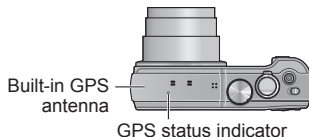

■ Displaying the status and result of positioning

The icons that indicate the status and result of positioning will appear on the monitor. When the camera successfully executes positioning, it records the current location and displays the place name information on the screen.



- Place name information
- Country/region
 - Province/state
 - City/borough/county
 - Town/village
 - Landmark

GPS reception icon

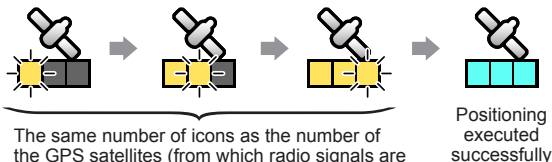

The same number of icons as the number of the GPS satellites (from which radio signals are successfully received) stop flashing and light (blue). If the three bars of the GPS reception icon do not light and the icon turns off, it means that positioning was unsuccessful.

Positioning result icons

Icon	Time elapsed after successful positioning
GPS ↕ ~5	Less than 5 minutes
GPS ↕ ~60	5 minutes to 1 hour have elapsed.
GPS ↕ ~120	1 hour to 2 hours have elapsed.
GPS ↕ 120~	2 hours or more have elapsed.
GPS	No positioning information has been acquired.

Even if GPS reception is good, it will take approx. 2 to 3 minutes to successfully execute positioning in the following cases:

- When positioning is executed for the first time
- When [GPS Setting] is set to [OFF]
- When [Airplane Mode] is set to [ON] and the camera is turned off
- While the battery is removed

Positioning can be executed faster when you download GPS assist data to the camera using the "GPS Assist Tool". (→140)

■ Information to be recorded on the pictures

When the camera successfully executes positioning, it records the following information in still pictures and motion pictures* (except for the picture quality settings of [PSH], [FSH], and [SH]).

- Latitude and longitude
- Place name information (Country/region, province/state, city/borough/county, town/village, landmark)

* Only the information determined at the time when the recording was started is recorded.

- GPS is displayed during playback for pictures that are recorded with location and place name information.
- Only the location information is recorded on a picture taken immediately after the camera had successfully executed positioning (i. e. before the place name information is displayed).
 - You can add the place name information to such a picture when you play it back.

■ Place name information

The most appropriate place name is displayed for place name information by searching for place names and landmarks from the database of this camera based on the latitude and longitude of positioning. (In some cases, the nearest place name or landmark may not be displayed.)

- If an appropriate place name or landmark is not found, [---] will appear even if the positioning is executed successfully. Even if [---] is displayed, in some cases you can select the place name information by using [GPS Area Select]. (→135)
- There are also cases where the landmarks you are looking for may not be registered in the camera database. Place name information such as landmarks is current as of December 2011. (Type of landmarks (→194))

- Place name information (place name and landmark name) may be different from the official names in some cases.

Executing the positioning function immediately to update the current location

If the displayed place name is different from the current location or a previous location is displayed, update the positioning information.

If some time has elapsed since the last time positioning was executed successfully (GPS \downarrow -60, GPS \leftrightarrow -120, GPS \uparrow -120, or GPS is displayed), we recommend updating the positioning information.

Before starting the procedure, move to a place where positioning can be performed successfully. (→127)

1 (Recording mode only)
Touch the GPS icon

2 Touch [Repositioning]

The GPS status indicator lights up and the positioning reception icons appear on the screen while positioning is executed.



- The positioning information is also updated by the following operations.
 - Set [GPS] in the Quick menu to [GPS] again.
 - Select [Repositioning] from the [GPS] menu.



■ Interval between positioning operations

Even if the positioning information is not updated, the camera automatically tries to execute positioning immediately after it is turned on and subsequently at regular intervals when [GPS Setting] is [ON].

Also, when [Airplane Mode] is set to [OFF], the camera automatically tries to execute positioning periodically according to the environment, even if the camera is turned off. Note, however, that the positioning operation is interrupted in the following cases.

- When the battery power is low and  is displayed.
- When the camera has not been turned on for a certain period of time.

■ Displaying the GPS reception status

- ① Select [GPS Setting] from the [GPS] menu: Perform steps **1** and **3** (→128)
 - ② Use the respective cursor buttons to select [INFO] and press [MENU/SET]
 - Press [MENU/SET] again to update the positioning information
- Checking GPS reception status
 - : Time when positioning is executed
 - : Number of GPS satellites from which the camera has received signals
 - : Latitude
 - Longitude

Changing place name information to be displayed

You can change the recorded place name information items to be displayed on the screen.

- 1 Press [MENU/SET]
- 2 Use the respective cursor buttons to select [GPS] menu and press [MENU/SET]
- 3 Use the respective cursor buttons to select [Area Info. Set] and press [MENU/SET]
- 4 Use the respective cursor buttons to select an item to be changed and press [MENU/SET]



- 5 Use the respective cursor buttons to set items that you want to display to [ON] and items that you do not want to display to [OFF] and press [MENU/SET]

Disabling the positioning function when the camera is turned off

When [GPS Setting] is [ON], the GPS function remains activated even if the camera is turned off.

To disable the positioning function when the camera is turned off, set [Airplane Mode] to [ON].

- 1** Press [MENU/SET]
- 2** Use the respective cursor buttons to select [GPS] menu and press [MENU/SET]
- 3** Use the respective cursor buttons to select [Airplane Mode] and press [MENU/SET]
- 4** Use the respective cursor buttons to select [ON] and press [MENU/SET]

- Electromagnetic radiation from the camera can affect instruments and meters. During takeoff and landing of an airplane or in other restricted areas, set [GPS Setting] to [OFF] or set [Airplane Mode] to [ON], and then turn off the camera.

Changing the place name information to be recorded

When there are other candidate locations as a result of positioning, you can change the location information to another place name or landmark in the neighborhood.

- When there is a choice for differing place name information,  appears in front of the place name information.
- You can also perform this operation by touching [GPS Area Select] after touching the GPS icon.

1 Press [MENU/SET]

2 Use the respective cursor buttons to select [GPS] menu and press [MENU/SET]

3 Use the respective cursor buttons to select [GPS Area Select] and press [MENU/SET]

4 Use the respective cursor buttons to select an item to be changed and press [MENU/SET]



5 Use the respective cursor buttons to select a place name or landmark from the displayed candidates and press [MENU/SET]

■ If you do not want to record a place name or landmark

When you select [Delete all place-names] in step **4**, above, the place names and landmarks are not recorded.

You can also select the level of the place name and landmark information to be excluded in step **5** above. All place names and landmarks that are below the selected level will be deleted from the recording. (For example, if you delete [County/Township], the lower level [City/Town/Village] and [Landmark] data will not be recorded either.)

- Note, however, that the latitude and longitude data are recorded. If you do not want to record the latitude and longitude data, set [GPS Setting] to [OFF].
 - To restore the place names and landmarks that you set not to be recorded, perform the [GPS Area Select] procedure again.
- A landmark may not be displayed at all or a different landmark may be displayed in places such as a large park. If the landmark that you want cannot be selected using [GPS Area Select], perform the [My Landmark] procedure (→152) before recording a picture or the [Edit Place Name] procedure after recording a picture. (→138)

Changing the recorded GPS information

[Edit Location]

You can edit the location information (latitude and longitude) recorded on still pictures and motion pictures.

- You can edit the location information only on a picture (GPS appears on the screen when this picture is played back) recorded with GPS information (location and place name information) when it was taken.
- When you edit the location information, the place name information is deleted.

Preparation: Before editing the location information using map data, be sure to copy the map data on the supplied DVD to a memory card. (→150)

- 1** Press [MENU/SET]
- 2** Use the respective cursor buttons to select [Playback] menu or [Map] menu and press [MENU/SET]
- 3** Use the respective cursor buttons to select [Edit GPS Data] and press [MENU/SET]
- 4** Use the respective cursor buttons to select a picture and press [MENU/SET]
- 5** Use the respective cursor buttons to select [Edit Location] and press [MENU/SET]
- 6** Use the respective cursor buttons to select an item and press [MENU/SET]

■ Specifying the location from the map

- ① Use the respective cursor buttons to select [Point on map] and press [MENU/SET]
- ② Move the map to a new location that you want to record on the picture and press [MENU/SET]
 - About map operation (→145)
 - A confirmation screen will appear. Select [Yes] to overwrite the location information.

■ Using the location information of another picture for reference

- ① Use the respective cursor buttons to select [Use another picture] and press [MENU/SET]
- ② Use the respective cursor buttons to select a picture and press [MENU/SET]
A map is displayed with the location recorded on a picture at the center.
- ③ Move a map to a new location that you want to record on the picture and press [MENU/SET]
 - About map operation (→145)
 - A confirmation screen will appear. Select [Yes] to overwrite the location information.

■ Applying the edited location information to other pictures

- ① Use the respective cursor buttons to select [Repeat] and press [MENU/SET]
The location information that was edited last will be displayed.
 - A confirmation screen will appear. Select [Yes] to overwrite the location information.

- The location information of a position specified on a map may deviate from the actual latitude and longitude coordinates.

[Edit Place Name]

You can edit a place name or landmark name recorded in a picture.

- 1** Press [MENU/SET]
- 2** Use the respective cursor buttons to select [Playback] menu or [Map] menu and press [MENU/SET]
- 3** Use the respective cursor buttons to select [Edit GPS Data] and press [MENU/SET]
- 4** Use the respective cursor buttons to select a picture and press [MENU/SET]
- 5** Use the respective cursor buttons to select [Edit Place Name] and press [MENU/SET]
- 6** Use the respective cursor buttons to select an item and press [MENU/SET]

■ Selecting a place name from candidates

- ① Use the respective cursor buttons to select [Candidate] and press [MENU/SET]
- ② Use the respective cursor buttons to select an item to be edited and press [MENU/SET]
Place names or landmark names near the location information recorded in a picture are searched for.
- ③ Select a place name or landmark name and press [MENU/SET]
 - A confirmation screen will appear. Select [Yes] to overwrite the place name information.

■ Directly editing a place name or landmark name

- ① Use the respective cursor buttons to select [Direct] and press [MENU/SET]
- ② Use the respective cursor buttons to select an item to be edited and press [MENU/SET]
- ③ Enter a name (Entering text: →94)
 - A confirmation screen will appear. Select [Yes] to overwrite the place name information.

■ Applying the edited place name and landmark name to other pictures

- ① Use the respective cursor buttons to select [Repeat] and press [MENU/SET]
The place name or landmark name that was selected or entered last will be displayed.
 - A confirmation screen will appear. Select [Yes] to overwrite the place name information.

Adjusting the time using GPS

You can automatically update the [Clock Set] of the camera using the date and time information contained in GPS radio signals. When you move to a different time zone from your home area and positioning is executed successfully, the camera automatically adjusts the time to the local time.

1 Select [Auto Clock Set] from [Setup] menu and press [MENU/SET]

- Displaying the [Setup] menu (→51)

2 Use the respective cursor buttons to select [ON] and press [MENU/SET]

3 (for the first time only)

3 When [Please set the home area] is displayed, press [MENU/SET]

4 Press ◀▶ to set your home area and press [MENU/SET]

City or area
name

Current time



◀ Difference from GMT (Greenwich Mean Time)

- When [Auto Clock Set] is set to [ON], the following settings are also changed automatically.
 - [GPS Setting]: [ON]
 - [World Time]: [Destination]
- You cannot select the area of [Destination]. (You can set the summer time for your destination.)
To select the area, set [Auto Clock Set] to [OFF], and set [World Time]. (→93)
- The date and time adjusted by [Auto Clock Set] are not as accurate as those of radio clocks. If the date and time are not adjusted accurately, use [Clock Set] to re-adjust the date and time.

Reducing the time required for positioning

You can reduce the time required for positioning by copying the predicted satellite information (GPS assist data) of GPS satellites required for positioning to the camera in advance.

- A computer that can be connected to the Internet is required to download the GPS assist data.
- If the camera's clock is not set, the GPS assist data cannot be used.
- The GPS assist data is valid for 30 days.
- The GPS assist data is updated once a day.
- The GPS assist data provider service may be changed or discontinued without prior notice. (The current service is provided as of January 2012.)

About the "GPS Assist Tool"

You can use the "GPS Assist Tool" to download the GPS assist data from the Internet and update the GPS assist data of the camera.

■ Operating environment

Supported OS	Windows® XP (32-bit) SP3 Windows Vista® (32-bit) SP2 Windows® 7 (32-bit, 64-bit) and SP1 Mac® OS X v10.4, v10.5, v10.6, and v10.7
---------------------	--------------------------------------------------------------------------------------------------------------------------------------------

- You do not need to install the software on your computer.

■ Using the "GPS Assist Tool"

You can operate the "GPS Assist Tool" using the following methods.

Connecting the camera and a computer to execute the "GPS Assist Tool" stored in the camera141

Copying the "GPS Assist Tool" to a memory card and use the card reader/writer (commercially available) to execute the "GPS Assist Tool"142

Using the “GPS Assist Tool”

■ Using “GPS Assist Tool” by connecting the camera and computer

Preparation: Turn on the computer and close all other open application programs.

- 1 Press [MENU/SET]
- 2 Use the respective cursor buttons to select [GPS] menu and press [MENU/SET]
- 3 Use the respective cursor buttons to select [Assist Data] and press [MENU/SET]
- 4 Use the respective cursor buttons to select [Update] and press [MENU/SET]
- 5 Use the respective cursor buttons to select [Connect USB] and press [MENU/SET]
- 6 Connect the camera to a computer

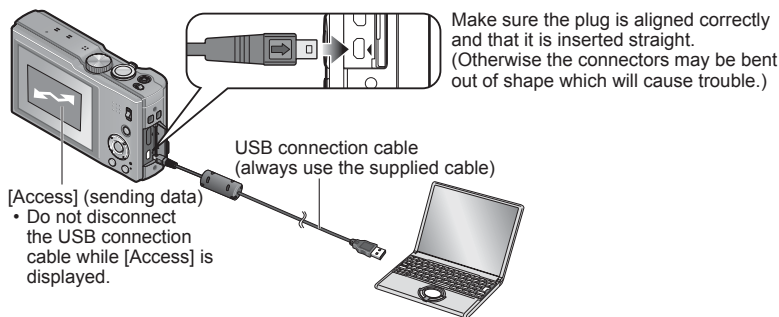

- 7 Start up the “GPS Assist Tool” on your computer and update the GPS assist data (→143)
The GPS assist data of the camera is updated.
- 8 Terminate the connection between the camera and computer and disconnect the USB connection cable

- You can also update the assist data if you select [GPS assist data] for [USB Mode] (→58) when you connect the camera to a computer.
- Do not use any other USB connection cables except the supplied one.

■ **Using a card reader/writer (commercially available)**

- Preparation:**
- Turn on the computer that is connected to a card reader/writer (commercially available) and close all other open application programs.
 - Insert a memory card in the camera before starting the updating procedure.

1 Perform steps **1** to **4** of “Using “GPS Assist Tool” by connecting the camera and computer” (→141)

2 Use the respective cursor buttons to select [SD card] and press [MENU/SET]

The “GPS Assist Tool” is copied to a memory card.

3 Turn off the camera and remove the memory card

4 Insert the memory card into a card reader/writer (commercially available) connected to the computer

5 Start up the “GPS Assist Tool” stored in the memory card on the computer and update the GPS assist data (→143)

6 Remove the memory card from the computer

7 Insert the memory card into the camera and turn on the camera

The GPS assist data of the camera is updated.

Updating the GPS assist data

1 Start up the “GPS Assist Tool” on the computer

■ Windows

- ① Double-click [GPSASIST.EXE] stored in the connected camera or memory card
The “GPS Assist Tool” will start up.
 - When the “GPS Assist Tool” is copied to the memory card, [GPSASIST.EXE] is stored in the [AD_LEICA] folder.

■ Mac

- ① Double-click [GPSASIST.DMG] stored in the connected camera or memory card
 - When the “GPS Assist Tool” is copied to the memory card, [GPSASIST.DMG] is stored in the [AD_LEICA] folder.
- ② Double-click [GPSASIST]
The “GPS Assist Tool” will start up.

2 Operate the “GPS Assist Tool”

- ① Click [Update]
 - ② Click [Yes]
 - ③ Click [OK]
 - ④ Click [Exit]
- Do not terminate the connection between the camera/card and computer until the data is updated.

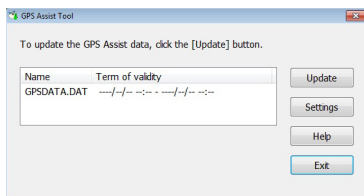

3 Terminate the connection between camera/card and computer

- Windows: Execute “Safely Remove Hardware” on the taskbar
- Mac: Open the Finder and click the eject icon that appears on the sidebar

■ Changing the proxy settings

Perform the proxy settings only if the GPS assist data cannot be updated successfully when the computer is connected to the Internet via proxy.

- ① Click [Settings]
- ② Perform the proxy settings

Windows: Enable [Use proxy server.] and change the settings.

Mac: Change the settings using the network settings screen of the displayed system environment settings screen.

Checking the expiration date of the GPS assist data

The GPS assist data expires in 30 days. We recommend using new GPS assist data.

- 1 Press [MENU/SET]**
- 2 Use the respective cursor buttons to select [GPS] menu and press [MENU/SET]**
- 3 Use the respective cursor buttons to select [Assist Data] and press [MENU/SET]**
- 4 Use the respective cursor buttons to select [Expiry Date] and press [MENU/SET]**

- You can also check the expiration date on the screen when the “GPS Assist Tool” is started up on the computer.

Using the map function

You can display a map showing the location where a picture was taken or your current location.

- If you copy the map data stored on the supplied DVD to a memory card, you can display more detailed maps. (→149)
- The place name information recorded on a picture and the place name displayed on a map may not be exactly the same.

Confirming the place where you took a picture using a map

When the location information or place name information is recorded on a picture, you can display a map showing the location where that picture was taken.

1 Display the pictures in playback mode

- GPS is displayed during playback for pictures that are recorded with location and place name information.

2 Press [MAP] button

A map of the place where you took the picture will appear. (If the picture was not recorded with location information or place name information, a small scale map will appear)

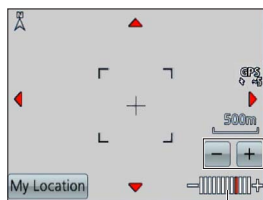

- You cannot change the display direction of the map. The map is oriented so that North is always at the top of the map.

Touch the +/- button to enlarge or reduce the map size. (You can also enlarge or reduce the map size using the zoom lever.)

Map scale level (The levels that can be displayed vary depending on the region)

- You can drag the screen or press the respective cursor buttons to operate the display location of a map.
- When you press the [] / [] button, it will return to the previous display.
- The actual place where you took the picture and the location displayed on the map may not be exactly the same.
- When you enlarge or reduce the map size, it may take some time before it is displayed.
- You can display the place where you took the pictures on a map only for pictures with location information or place name information recorded using Leica digital cameras equipped with a GPS function.

Displaying your current location on a map

When positioning is executed successfully using GPS, you can display your current location on a map.

- Make sure to set [GPS Setting] to [ON]. (→128)

1 Press the [MAP] button in playback mode

2 Touch [My Location]

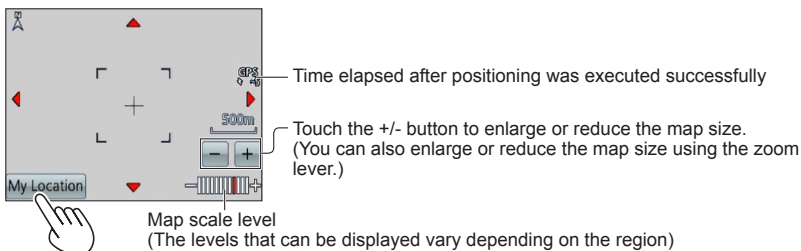

- You can drag the screen or press the respective cursor buttons to operate the display location of a map.
- When you press the [Home / Back] button, it will return to the previous display.
- You can also use [My Location] in the [Map] menu to display the current location on a map.

When the current location is being displayed, the camera executes positioning at regular intervals. When positioning is executed successfully, the map display is updated.

- This camera is not equipped with a navigation function.
- The actual place where you took the pictures and the location displayed on the map may be quite different under the following conditions.
 - When some time has elapsed after positioning was executed successfully.
 - When the camera is being moved at high speed

Displaying only pictures taken in the same area

You can select the area of a picture on a map to narrow down the pictures to be displayed.

1 Press the [MAP] button in playback mode

2 Display the map so that the place where you took the pictures is moved within the display range of the frame

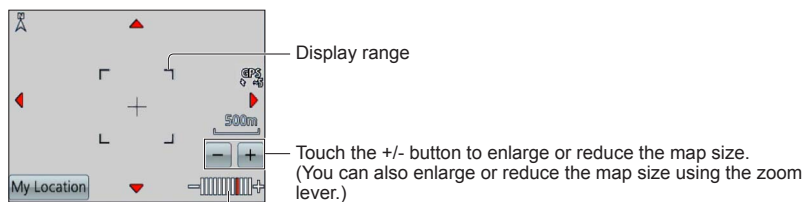

Map scale level (The levels that can be displayed vary depending on the region)

- You can drag the screen or press the respective cursor buttons to operate the display location of a map.

3 Press the [DISP.] button



4 Touch a picture in the picture list to display it

Only pictures taken at a location within the display range of the frame are displayed ([Filtering Play]).

- You can also display a picture by selecting it using the respective cursor buttons and pressing [MENU/SET].
- Select [Normal Play] from the [Playback Mode] menu to cancel [Filtering Play].

- When the map is at its maximum size the location where the picture was taken and the picture list will not be displayed.

Displaying a map by selecting a country or region

You can select a place name that you want to display and show it on a map.

- 1** Press [MENU/SET] in playback mode
- 2** Use the respective cursor buttons to select [Map] menu and press [MENU/SET]
- 3** Use the respective cursor buttons to select [Select Area] and press [MENU/SET]
- 4** Use the respective cursor buttons to select [From Place Name] and press [MENU/SET]
- 5** Use the respective cursor buttons to select a country/region and press [MENU/SET]

Using the map data on the DVD

You can use “LEICA Map Tool” to copy the map data on the DVD (supplied) to a memory card. When the map data is copied to the memory card, detailed maps can be displayed on the camera.

- Install “LEICA Map Tool” on your computer before starting the detailed map display procedure.

Installing “LEICA Map Tool”

Close all other open application programs before inserting a DVD in the computer drive.

■ Operating environment

Supported OS	Windows® XP (32-bit) SP3 Windows Vista® (32-bit) SP2 Windows® 7 (32-bit, 64-bit) and SP1 Mac® OS X v10.4, v10.5, v10.6, and v10.7
---------------------	--------------------------------------------------------------------------------------------------------------------------------------------

■ Windows

- 1 Insert the DVD**
- 2 Click [LEICA Map Tool]**
Perform the rest of the steps in accordance with the instructions displayed on the computer screen.

■ Mac

- 1 Insert the DVD**
- 2 Double-click the recognized disc to open**
- 3 Double-click the [MAPTOOL] folder to open**
- 4 Double-click [LEICA Map Tool.pkg]**
Continue the installation procedure following the instructions displayed on the screen.

Copying the map data to a memory card

- Preparation:**
- Install “LEICA Map Tool” on your computer before starting the copying procedure. (→149)
 - Turn on the computer and close all other open application programs.
 - Insert the supplied DVD in your computer drive before starting the copying procedure.
(Windows: Close the installation menu that starts automatically.)

1 Insert the memory card into a card reader/writer (commercially available) connected to the computer

2 Start “LEICA Map Tool” installed in your computer

- Windows: Click [Start] → [All Programs] → [LEICA] → [LEICA Map Tool] → [LEICA Map Tool]
- Double click on the shortcut icon on the desktop if you chose to create one at the time of installation.
- Mac: Double-click [LEICA_Map_Tool] in [Applications] (Applications)

3 Select a card from the pull-down menu (A)

4 Click the checkbox to select a region to be copied (B)

5 Click [Execute] (C)

- Perform the rest of the steps in accordance with the instructions displayed on the computer screen.

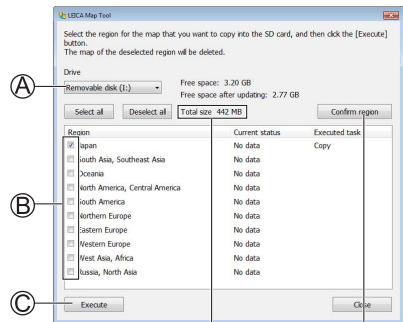

Size of data to be copied

The region confirmation window will appear.

6 After copying is finished, click [Close] and remove the memory card from the computer

- Windows: Execute “Safely Remove Hardware” on the taskbar
- Mac: Open the Finder and click the eject icon that appears on the sidebar

■ Copying map data directly to a memory card in the camera from the computer instead of a card reader/writer (commercially available)

You can copy the map data to a memory card inserted in the camera by connecting the camera to a computer using the supplied USB connection cable.

- Select the connected camera in step 3 (→150).
- For details on making the connection with a computer (→164).
- Do not use any other USB connection cables except the supplied one.

■ Deleting the map data

You can free up space on the memory card by deleting map data that is no longer required.

① Click the already copied region in step 4 (→150)

- The [Executed task] field will change to [Delete].

② Click [Execute]

- Perform the rest of the steps in accordance with the instructions displayed on the computer screen.

- Since the map data volume is large, be sure to check the free space on the memory card before copying the data. (A memory card of at least 8 GB is needed to copy the map data for all the regions.)
- Since the map data volume is large, copying will take some time.
- When map data is copied to a memory card, the number of recordable pictures and recording time will decrease.
- The maps are copied to the memory card. If a different card is inserted in the camera, no maps are displayed.
- When a memory card is formatted (initialized), all data, including the map data, is deleted.
- Use "LEICA Map Tool" for copying and deleting the map data. When the map data is deleted or moved to another location using the file operation of your computer, the maps may not be displayed correctly.

Registering my landmark

You can register a user-defined location that is not registered in this camera as my landmark in order to display it when positioning is executed or to record it on a picture. (Up to 50 landmarks)

- Unless the map data is copied to a memory card, My landmark cannot be registered. Before registering My landmark, copy the map data on the DVD (supplied) to the memory card. (→149)

Registering my landmark from a map

You can register a location specified on a map as My landmark.

- 1** Press [MENU/SET] in playback mode
- 2** Use the respective cursor buttons to select [Map] menu or [GPS] menu and press [MENU/SET]
- 3** Use the respective cursor buttons to select [My Landmark] and press [MENU/SET]
- 4** Use the respective cursor buttons to select [None] and press [MENU/SET]
- 5** Use the respective cursor buttons to select [Point on map] and press [MENU/SET]
- 6** Display the location that you want to register at the center of the map and press [MENU/SET]
 - Operations available when a map is displayed (→145)
- 7** Press [MENU/SET]
- 8** Enter my landmark name (Entering text: →94)

- You can use the GPS to register your current location as My landmark. If you have moved to a location where positioning is enabled and when positioning is executed successfully before starting the My landmark registration procedure, the current location will be displayed at the center of the map.

Registering the recording location as my landmark

You can use the location information of a picture to register it as My landmark.

- 1** Press [MENU/SET] in playback mode
- 2** Use the respective cursor buttons to select [Map] menu or [GPS] menu and press [MENU/SET]
- 3** Use the respective cursor buttons to select [My Landmark] and press [MENU/SET]
- 4** Use the respective cursor buttons to select [None] and press [MENU/SET]
- 5** Use the respective cursor buttons to select [Picture location data] and press [MENU/SET]
- 6** Display a picture that was taken at a location you want to register as a landmark
- 7** Press [MENU/SET]
- 8** Display the location that you want to register at the center of the map and press [MENU/SET]
 - Operations available when a map is displayed (→145)
- 9** Press [MENU/SET]
- 10** Enter my landmark name (Entering text: →94)

Selecting My landmark and displaying it on a map

You can display a map by moving the registered My landmark to the center.

- 1** Press [MENU/SET] in playback mode
- 2** Use the respective cursor buttons to select [Map] menu and press [MENU/SET]
- 3** Use the respective cursor buttons to select [Select Area] and press [MENU/SET]
- 4** Use the respective cursor buttons to select [From My Landmark] and press [MENU/SET]
- 5** Use the respective cursor buttons to select My landmark and press [MENU/SET]

Editing or deleting my registered landmark

- 1** Press [MENU/SET] in playback mode
- 2** Use the respective cursor buttons to select [Map] menu or [GPS] menu and press [MENU/SET]
- 3** Use the respective cursor buttons to select [My Landmark] and press [MENU/SET]
- 4** Use the respective cursor buttons to select an already registered landmark and press [MENU/SET]
- 5** Use the respective cursor buttons to select an item and press [MENU/SET]

[Edit]	Edits my landmark name.
[Delete]	Deletes my registered landmark.

Playing back on a TV

You can view pictures on a TV by connecting your camera to it with the HDMI mini cable (available as accessory →9) or the AV cable (included in scope of delivery →9).

● Also consult the TV's instructions.

Preparation:

- Set [Output] to connect your camera to a TV using the AV cable (→59)
- Turn off both camera and TV.

1 Connect the camera to the TV

■ To connect with the HDMI mini cable

The HDMI mini cable can be used to enable viewing of still and motion pictures in high resolution.

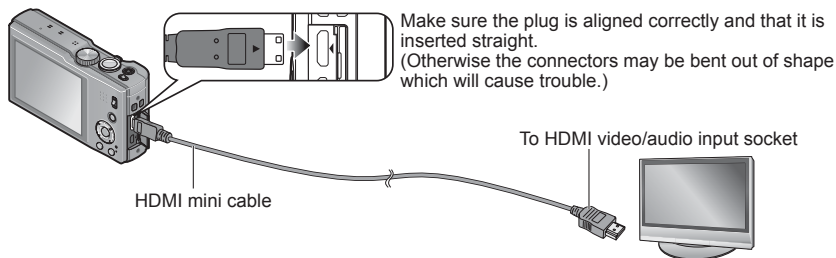

■ To connect with the AV cable

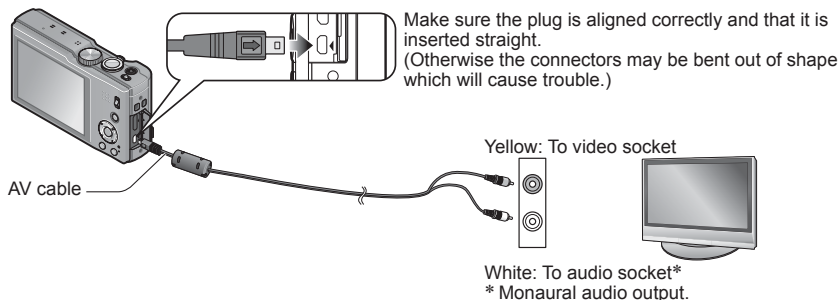

2 Turn on the TV

- Set to auxiliary input.

3 Turn on the camera

4 Set the REC/PLAY switch to

■ To connect with the HDMI mini cable

- Always use the genuine Leica HDMI mini cable (available as accessory →9).
- Some of the playback functions cannot be performed.
- [Playback], [GPS], [Map], and [Setup] menus cannot be used.
- Bars may appear at the sides or at the top and bottom of the screen, depending on the aspect ratio setting.
- When an HDMI mini cable is connected, pictures are not displayed on the monitor.
- HDMI output will be cancelled if a USB connection cable is connected simultaneously.
- When the AV cable and the HDMI mini cable are connected at the same time, no picture is output from the AV cable.
- Pictures may be momentarily distorted immediately after commencing playback or pausing on certain televisions.
- Audio output is stereo.

■ To connect with the AV cable

- Always use the genuine Leica AV cable.
- You can play back pictures on TVs in other countries (regions) which use the NTSC or PAL system when you set [Video Out] in [Setup] menu.
(With camera model 18 175)
- Pictures rotated to portrait may be blurred slightly.
- Change the picture mode settings on the TV if aspect ratios are not displayed correctly on widescreen or high-definition televisions.

■ When TVs or DVD recorders have an SD card slot

Insert the SD Memory Card into the SD card slot

- Still pictures can be played back.
- AVCHD motion pictures can be played back on TVs displaying the AVCHD logo.
- When using both SDHC and SDXC Memory Cards, be sure to play each type of card in equipment compatible with the particular format.
- You may not be able to play back panorama pictures. Also you cannot perform automatic scrolling playback of panorama pictures.

HDTV Link (HDMI)

What is the HDTV Link?

- This function allows you to use the remote control of compatible TVs for easy operations when the camera is connected to a HDTV Link compatible device using the HDMI mini cable (available as accessory →9) for automatic linked operations. (Not all operations are possible.)
- HDTV Link is a unique function built on a HDMI control function using the standard HDMI CEC (Consumer Electronics Control) specification. Linked operations with HDMI CEC compatible devices made by other companies are not guaranteed. When using devices made by other companies that are compatible with HDTV Link, refer to the operating instructions for the respective devices.
- The camera is compatible with HDTV Link Ver.5. HDTV Link Ver.5 is the newest version and is also compatible with existing HDTV Link compatible devices.

- Always use the genuine Leica HDMI mini cable (available as accessory →9).
- Cables that do not comply with HDMI standards will not work.
- If you are unsure whether or not the TV you are using is compatible with HDTV Link, read the instructions for the TV.
- If the [HDTV Link] setting on the camera is [ON], operations via the camera buttons will be limited.
- Ensure that the television you are connecting to has been set up to enable HDTV Link (HDMI) (consult your television instructions for details).

Preparation: Set [HDTV Link] to [ON] (→59).

- 1 Connect the camera to a HDTV Link (HDMI)-compatible television with the HDMI mini cable** (available as accessory →9) (→155)
- 2 Turn on the camera**
- 3 Set the REC/PLAY switch to **
- 4 Proceed with the operation while referring to what is displayed on the TV screen**
 - When operating, refer to the HDTV Link operating panel.

■ Other related operations

- Power OFF
The camera's power can also be switched off when switching the television's power off with the remote control.
- Automatic input select
 - This function automatically switches the television input to the camera screen whenever the camera's power is switched on while it is connected via the HDMI mini cable. The television can also be switched on via the camera from Standby Mode (if "Power on link" on the television is set to "on").
 - If HDTV Link (HDMI) does not function correctly (→181)
- To display a map on the TV screen choose [Display map] from the menu by remote control. (Option available only with HDTV Link (HDMI))

Playing back 3D still pictures

If you connect this camera to a 3D-capable TV and play back still pictures that you recorded in 3D, you can enjoy impressive 3D still pictures on the TV. If a 3D-capable TV has an SD card slot, you can play back 3D still pictures that you recorded by inserting the card into the slot.

Preparation: Set [3D Playback] to [3D] (→59).

1 **Connect the camera to a 3D-capable TV with the HDMI mini cable** (available as accessory →9) **to display the playback screen** (→155)

2 **Display still pictures recorded in 3D**

- When the [HDTV Link] setting on the camera is set to [ON] and the camera is connected to a HDTV Link (HDMI)-compatible TV, it automatically switches its input and the playback screen is displayed.
- [3D] appears on the thumbnail of the 3D still pictures.

■ **To select and play back only still pictures recorded in 3D**

Select [3D Play] in [Filtering Play] in the [Playback Mode] menu (→114)

■ **To perform Slide Show playback of only still pictures recorded in 3D**

Select [3D Play] in [Slide Show] in the [Playback Mode] menu (→112)

■ **The functions that are not operational or available for 3D still pictures:**

- [Setup] menu
- [Playback] menu
- [GPS] menu
- [Map] menu
- Playback Zoom
- Delete

■ **To switch the playback method for the still pictures recorded in 3D**

- ① Select the picture recorded in 3D
- ② Select [2D/3D Settings] in the [Playback Mode] menu and then press [MENU/SET] (→111)

- The playback mode will switch to 3D if it is playing back in 2D (conventional image), or it will switch to 2D if it is playing back in 3D.
- If you feel tired, uncomfortable or otherwise strange when playing back pictures recorded in 3D, set to 2D.

- On the monitor of this camera, 3D still pictures will be played back in 2D (conventional pictures).
- If you switch between 3D still pictures and normal still pictures while playing them back, the monitor image will be black for a few seconds.
- If you select a thumbnail of 3D still pictures or display a thumbnail after playing back 3D still pictures, it may take a few seconds to start playing back or displaying the pictures.
- Viewing 3D still pictures too close to a TV may cause eyestrain.
- When a TV has not been converted for viewing 3D still pictures, do the necessary settings on the TV. (For details about the necessary preparation of the TV, read the TV's instructions.)
- When an image is not suitable for 3D viewing (due to excessive parallax, etc.)
 - During Slide Show playback: The image is displayed in 2D.
 - During [Filtering Play]: A message appears confirming whether to display the image in 3D or not.
- When a 3D image is played back on a TV that is not 3D-capable, 2 pictures may appear side-by-side on the screen.
- You can store 3D still pictures on a computer and on some recorders. (→161)

Copying the recorded still and motion pictures

The methods for copying still and motion pictures recorded with this camera to other devices vary according to the file format (JPEG, MPO, AVCHD, MP4, Motion JPEG). Follow the correct method for your device.

Copying by inserting the SD card into a recorder

You can copy pictures using compatible equipment (such as Blu-ray disc recorders) with support for each file format.

- See the recorder's instructions for details about copying and playing back.

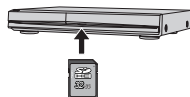

Dubbing playback pictures with the AV cable

Videos that are played on this camera can be dubbed on media such as a disc, hard disk or videotape using a device such as a video recorder. This method is useful as it allows dubbing to be performed even with devices that are not compatible with high definition images. The picture quality will be reduced from high definition to standard definition. Audio will be monaural.

1 Connect the camera to a recorder

2 Start playback on the camera

3 Start recording on the recorder

- To stop recording (dubbing), stop the recording on your recorder first before stopping the playback on the camera.

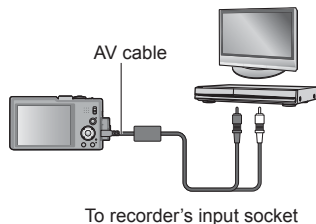

- Always use the genuine Leica AV cable (included in scope of delivery →9).
- When using a TV with a 4:3 aspect ratio, always change the camera's [TV Aspect] setting (→59) to [4:3] before dubbing. Motion pictures copied in the [16:9] setting will appear vertically stretched when viewed on a 4:3 TV screen.
- For details on dubbing and playback methods, refer to your recorder's instructions.

Copying the recorded image data to a computer with the supplied software

Using the software on the supplied DVDs, you can copy the image data recorded with this camera in all file formats to a computer – with Adobe® Photoshop® Elements® for still pictures and Adobe® Premiere® Elements® for motion pictures.

Three preparatory steps are necessary when initially installing the software to utilize it.

1 Install the software to your computer

- For details about the software on the supplied DVDs, operation environment and installation, refer to the camera Basic Instructions.

2 Register your camera on the Leica Camera AG homepage

- a. Open an account at <http://owners.leica-camera.com>. As a result, you will receive access to the “Owners area”.
- b. Register your camera at “My products”. Do so by following the respective instructions.
 - The key with which you can activate the software will be sent to you by email.

3 Activate the software with the key (numbers) you have received

- Do so by following the respective instructions appearing after opening the software.

■ Using the software

1 Connect the camera to your computer

- For connection procedures (→164)

2 Use Adobe® Photoshop® Elements® to copy still pictures, and Adobe® Premiere® Elements® to copy motion pictures to your computer

- For details on how to operate the software, refer to the online assistance.

- Files and folders containing copied AVCHD motion pictures cannot be played back or edited if they have been deleted, modified, or moved using Windows Explorer or similar methods.
- Always use Adobe® Premiere® Elements® when handling AVCHD motion pictures.

Using with your PC

Still/motion pictures can be copied from the camera to your computer by connecting the two.

- Some computers can read directly from the camera's memory card.
For details, see the instructions for your computer.
- If your computer does not support SDXC Memory Cards a message will be displayed requesting you to format the card. (Do not format the card. This will erase recorded pictures.)

■ Computer specifications

You can connect the camera to a computer that can detect a mass storage device (device that stores a large volume of data).

- Windows: Windows 7 / Windows Vista / Windows XP / Windows 2000 / Windows Me
- Mac: OS X10.1 - 10.7

Some motion pictures recorded in [AVCHD] may not be scanned correctly by copying a file or folder.

- When using Windows, be sure to use the supplied software on the supplied disc to copy motion pictures recorded in [AVCHD].
- When using a Mac with "iMovie '11", you can copy motion pictures recorded in the [AVCHD] format, but not those recorded in the [AVCHD] progressive format. (For details about iMovie '11, please contact Apple Inc.)

Copying still and motion pictures recorded in [MP4] and [High Speed Video] Scene Mode (except AVCHD motion pictures)

Preparation:

- Charge the battery sufficiently.
- When importing pictures from the built-in memory, remove any memory card.
- Turn on the camera and the computer.

Make sure the plug is aligned correctly and that it is inserted straight.
(Otherwise the connectors may be bent out of shape which will cause trouble.)

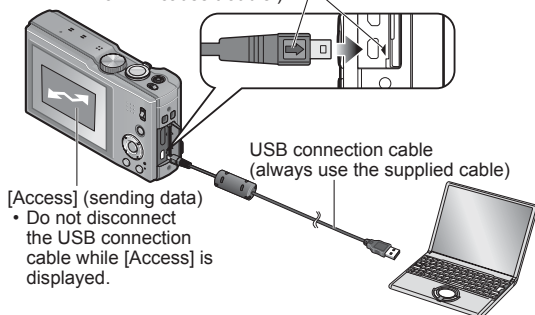

1 Connect the camera to the computer

- Please make sure you use the supplied USB connection cable. Use of cables other than the supplied USB connection cable may cause malfunction.

2 Use the respective cursor buttons on the camera to select [PC], and press [MENU/SET]

- A message may be displayed on the monitor if [USB Mode] (→58) is set to [PictBridge(PTP)]. Select [CANCEL] to close the screen, and set [USB Mode] to [PC].
- When [USB Mode] (→58) is set to [GPS assist data], the folder storing the pictures will not be displayed. Set [USB Mode] to [PC].

3 Operate with your computer

You can save pictures to use on your computer by dragging and dropping folders and files into separate folders on your computer.

■ To cancel connection

Windows: Execute "Safely Remove Hardware" on the taskbar

Mac: Open the Finder and click the eject icon that appears on the sidebar

■ When using Windows XP, Windows Vista, Windows 7, or Mac OS X

The camera can be connected to your computer even if [USB Mode] (→58) is set to [PictBridge(PTP)].

- Only picture output can be performed.
- It may not be possible to import if there are 1000 or more pictures on the card.
- Motion pictures cannot be read. (Excluding [High Speed Video])

■ Folder and file names on computer

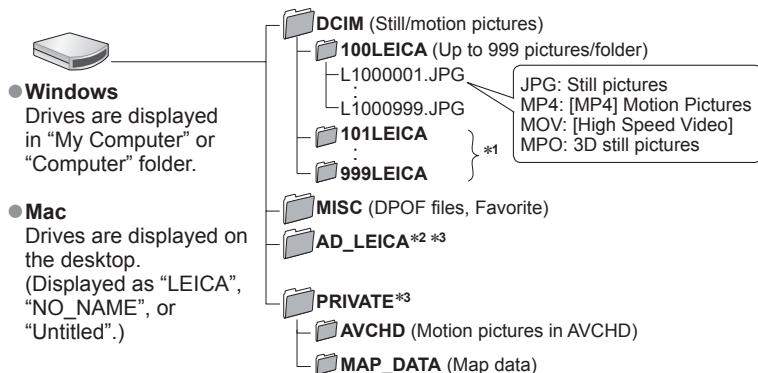

*1 New folders are created in the following cases:

- When pictures are taken to folders containing files numbered 999.
- When using cards already containing the same folder number (for example, pictures taken with other cameras, etc.).
- When recording after performing [No.Reset].

*2 When "GPS Assist Tool" is copied to a memory card, it is stored in this folder.

*3 This folder is not created in the built-in memory.

- **Do not delete or modify folders or data in the AVCHD folder using Windows Explorer or other tools. The camera may be unable to play back the motion pictures correctly if any of these files are deleted or modified. For data management and editing of AVCHD motion pictures, use the supplied software on the supplied disc.**

- Do not use any USB connection cables other than the supplied one.
- Turn off the power before inserting or removing memory cards.
- When the battery begins to run out during communication, a warning beep sounds. Cancel communication via your computer immediately. Use a sufficiently charged battery.
- Setting the [USB Mode] to [PC] removes the need to make the setting each time the camera is connected to the computer.
- For more details, consult your computer's instructions.

Printing

You can connect directly to a PictBridge-compatible printer for printing.

- Some printers can print directly from the camera's memory card.

For details, see the instructions for your printer.

Preparation:

- Charge the battery sufficiently.
- When printing pictures from the built-in memory, remove any memory cards.
- Adjust the print quality or other settings on your printer, as needed.
- Turn on the camera and the printer.

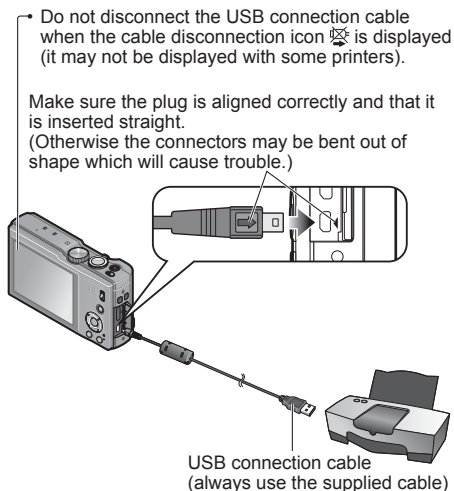

1 Connect the camera to the printer

- Please make sure you use the supplied USB connection cable. Use of cables other than the supplied USB connection cable may cause malfunction.

2 Use the respective cursor buttons on the camera to select [PictBridge(PTP)], and press [MENU/SET]

3 Use the respective cursor buttons to select a picture to print and press [MENU/SET]

4 Use the respective cursor buttons to select [Print start] and press [MENU/SET] (Print settings (→169))

■ **To cancel print** Press [MENU/SET].

- Do not use any other USB connection cables except the supplied one.
- Disconnect the USB connection cable after printing.
- Turn off the power before inserting or removing memory cards.
- When the battery begins to run out during communication, a warning beep sounds. Cancel printing and disconnect USB connection cable. Use a sufficiently charged battery.
- Motion pictures cannot be printed.

Printing multiple pictures

- 1 Use the respective cursor buttons to select [Multi Print] in step 3** (→166)
- 2 Use the respective cursor buttons to select the desired mode and then press [MENU/SET]**
 - **[Multi Select]:**
 - ① Scroll between the pictures with the respective cursor buttons, select the pictures to print with the [DISP.] button. (To erase a selection mark, press the [DISP.] button again.)
 - ② Press [MENU/SET] when the selection is complete.
 - **[Select All]:** Prints all pictures.
 - **[Print Set (DPOF)]:** Prints pictures selected in [Print Set]. (→123)
 - **[Favorite]:** Prints pictures selected as [Favorite]. (→122)
- 3 Use the respective cursor buttons to select [Print start] and then press [MENU/SET]**
(Print settings (→169))
 - Select [Yes] if print confirmation screen is displayed.

- An orange “●” displayed during printing indicates an error message.
- The printing process may be executed in several steps if a large number of pictures were selected.
(Remaining sheets display may differ from the number of pictures set for printing.)

Printing with date and text







■ Printing date without [Text Stamp]

- Printing in store: Only the recording date can be printed. If you want the printing date.
 - Making [Print Set] (→123) settings on the camera in advance allows settings for numbers of copies and date printing to be designated before giving the card to the store.
 - When printing still pictures with a 16:9 aspect ratio, check in advance that the store can accept this size.
- Using a printer: The recording date can be printed by setting [Print Set] on the camera, or by setting [Print with Date] (→169) to [ON] when connecting to a printer compatible with date printing.
- The time and the date can be set to be printed on the picture when taking the picture by activating the [Date Stamp] function in the [Rec] menu. (→105)



Making print settings on the camera

Make the settings before selecting [Print start].

1 Use the respective cursor buttons to select the mode and press [MENU/SET]

Mode	Settings
[Print with Date]	[ON]/[OFF]
[Num.of prints]	Set the number (up to 999 pictures)
[Paper Size]	When  is selected, the printer settings take priority.
[Page Layout]	 (printer takes priority) /  (1 picture, no border) /  (1 picture, with border) /  (2 pictures) /  (4 pictures)

2 Use the respective cursor buttons to select setting and press [MENU/SET]

- The modes may not be displayed if incompatible with the used printer.
- To arrange  "2 pictures" or  "4 pictures" in the same still picture, set the number of prints for the still picture to 2 or 4.
- To print to paper sizes/layouts not supported by this camera, set to  and make settings on the printer. (Consult your printer's instructions.)
- Even with completed [Print Set] settings, dates may not be printed, depending on the shop or printer used.
- When setting [Print with Date] to [ON], check the date printing settings on the printer (printer settings may be prioritized).

List of monitor displays

The screen shown here is only an example. The actual display may vary.

- Press the [DISP.] button to change displays.

■ In recording

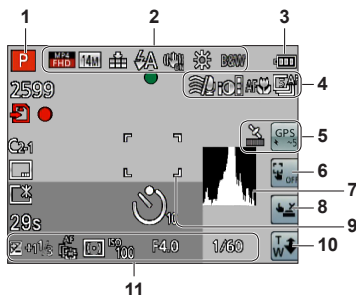

- 1 Recording Mode (→25)
- 2 Backlight Compensation (→32, 34)
Recording quality (→107)
Resolution (→95)
Quality (→96)
Flash (→66)
Optical Image Stabilizer (→104)
Camera shake alert (→27)
[Motion Deblur] (→33)
White Balance (→97)
Color Mode (→103)
- 3 Battery capacity (→16)
- 4 Wind cut (→108)
Intelligent exposure (→101)
Macro recording (→68)
Series exposure Mode (→87)
Auto Bracket (→72)
- 5 GPS reception icon (→129)
Positioning result icons (→129)
- 6 Touch AF/AE function canceled (→30)
- 7 Histogram (→62)
- 8 Touch shutter release (→29)
- 9 AF area (→28)
- 10 Touch zoom (→64)
- 11 Exposure Compensation (→71)
AF Tracking (→35, 99)
AF Assist Lamp (→103)
Metering Mode (→101)
ISO Sensitivity (→96)
Aperture value/Shutter speed (→27, 73)
Minimum shutter speed (→102)

(Continued on the next page)

The screen shown here is only an example. The actual display may vary.

- Press the [DISP.] button to change displays.

■ In recording

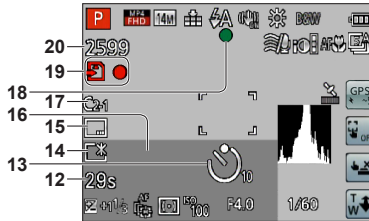

- | | |
|---------------------------------------------------------------------------------------------------------------------------------------------------------------------------------------------------------------------------------------------------------------------------------------------------------------------------------------------------------------------------------------------------------------------------------------|----------------------------------------------------------------------------------------------------------------------------------------------------------------------------------------------------------------------|
| <p>12 Elapsed recording time*1 (→37)
[GPS Area Select] (→135)</p> <p>13 Self-timer Mode (→70)</p> <p>14 LCD Mode (→55)
LCD power save (→57)</p> <p>15 Date Stamp (→105)</p> <p>16 Current date/time
World time (→93)
Name*2 (→82, 90)
Age in years/months*2 (→82, 90)
Place name information*2 (→135)
Destination settings*2 (→92)
Travel elapsed days*2 (→92)</p> | <p>17 Custom Set (→85)</p> <p>18 Focus (→28)</p> <p>19 Save destination (→20)
Recording state</p> <p>20 Number of recordable pictures (→22)
Available recording time*1 (→37)</p> |
|---------------------------------------------------------------------------------------------------------------------------------------------------------------------------------------------------------------------------------------------------------------------------------------------------------------------------------------------------------------------------------------------------------------------------------------|----------------------------------------------------------------------------------------------------------------------------------------------------------------------------------------------------------------------|



- Focus range (→68)
Zoom (→63)

*1 XXhXXmXXs, RXXhXXmXXs
[h], [m] and [s] indicate "hour", "minute" and "second".

*2 The displaying is performed in the following priority order: location name information, travel destination, name ([Baby]/[Pet]), and name ([Face Recog.]). When the place name information or the number of days elapsed from day of departure are displayed, age in years/months is not displayed.

The screen shown here is only an example. The actual display may vary.

- Press the [DISP.] button to change displays.

■ In playback

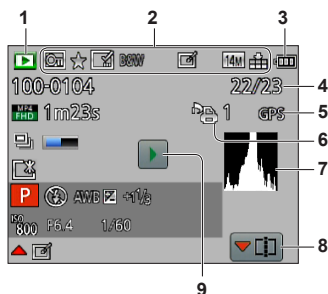

- | | |
|---------------------------------------|--------------------------------------|
| 1 Playback Mode (→111) | 6 Print settings (→123) |
| 2 Protected picture (→124) | 7 Histogram (→62) |
| Favorites (→122) | 8 Video Divide (→48) |
| Date/text stamped display (→105, 118) | Series exposure group display (→109) |
| Color Mode (→103) | 9 Motion picture playback (→45) |
| Retouched picture (→115, 116) | Panorama playback (→80) |
| Resolution (→95) | Series exposure playback (→109) |
| Quality (→96) | |
| 3 Battery capacity (→16) | |
| 4 Picture number/Total pictures (→42) | |
| 5 GPS (→127) | |

(Continued on the next page)

The screen shown here is only an example. The actual display may vary.

- Press the [DISP.] button to change displays.

■ In playback

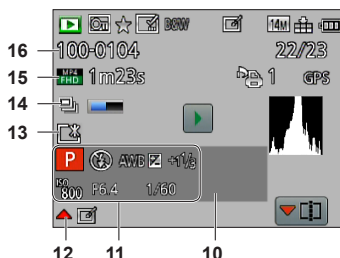

- | | |
|-----------------------------------------------------------------------------------------------------------------------------------------------------------------------------------------------------------------------------------------------------------------------------------------------------------------------------------------------------------------------------------------------------------------------------------------------------------------------------------------------------------------------------------------------------------------------------------------------|-----------------------------------------------------------------------------------------------------------------------------------------------------------------------------------------------------------------------------------------------------------------------------------------------------|
| <p>10 Recording date/time
World time (→93)
Name*1 (→82, 90)
Age in years/months*1 (→82, 90)
Place name information*1 (→135)
Destination settings*1 (→92)
Travel elapsed days*1 (→92)
Title*1 (→117)</p> <p>11 Recording Mode (→25)
Flash (→66)
White Balance (→97)
Exposure Compensation (→71)
ISO Sensitivity (→96)
Aperture value/Shutter speed (→27, 73)
Elapsed playback time*2 (→45)</p> <p>12 [Auto Retouch] (→115)
[Creative Retouch] (→116)</p> <p>13 LCD Mode (→55)
LCD power save (→57)</p> | <p>14 Series exposure information is being retrieved (→109)</p> <p>15 Recording quality (→107)
Motion picture recording time*2 (→45)
Number of serial exposure pictures (→109)</p> <p>16 Folder/File number (→42, 165)
Cable disconnection warning icon (→166)</p> |
|-----------------------------------------------------------------------------------------------------------------------------------------------------------------------------------------------------------------------------------------------------------------------------------------------------------------------------------------------------------------------------------------------------------------------------------------------------------------------------------------------------------------------------------------------------------------------------------------------|-----------------------------------------------------------------------------------------------------------------------------------------------------------------------------------------------------------------------------------------------------------------------------------------------------|

*1 The displaying is performed in the following priority order: location name information, title, travel destination, name ([Baby]/[Pet]), and name ([Face Recog.]). When the place name information or the number of days elapsed from day of departure are displayed, age in years/months is not displayed.

*2 XXhXXmXXs
[h], [m] and [s] indicate "hour", "minute" and "second".

Message displays

Meanings of and required responses to major messages displayed on the monitor.

[This memory card cannot be used]

- A MultiMediaCard was inserted.
→ Not compatible with the camera. Use a compatible card.

[Some pictures cannot be deleted] [This picture cannot be deleted]

- Non-DCF pictures (→42) cannot be deleted.
→ Save the needed data on a computer or other device, and then use [Format] on the camera. (→60)

[No additional selections can be made]

- The number of pictures that can be deleted at once has been exceeded.
- More than 999 pictures have been set as [Favorite].
- The number of pictures allowing [Title Edit], [Text Stamp] or [Resize] (multiple settings) at once has been exceeded.

[Cannot be set on this picture]

- [Print Set], [Title Edit], or [Text Stamp] cannot be made for non-DCF pictures (→42).

[Please turn camera off and then on again] [System Error]

- The lens is not working correctly.
→ Turn the camera off and back on again.
(Consult your Leica dealer or the nearest Leica Customer Care center if the message is still displayed)

[Some pictures cannot be copied] [Copy could not be completed]

- Pictures cannot be copied in the following cases.
→ A picture of same name already exists in built-in memory when copying from card.
→ A file is not of DCF standard (→42).
→ A picture taken or edited on a different device.

[Not enough space on built-in memory] [Not enough memory on the card]

- There is no space left on the built-in memory or the card. When you copy pictures from the built-in memory to the card (batch copy), the pictures are copied until the capacity of the card becomes is depleted.

[Built-In Memory Error] [Format built-in memory?]

- Is displayed when formatting the built-in memory with a computer, etc.
→ Reformat directly using the camera. The data will be deleted.

[Memory card error. This card cannot be used in this camera. Format this card?]

- The card format cannot be used with this camera.
→ Save the needed data on a computer or an other device, and then use [Format] on the camera. (→60)

[Insert SD card again] [Try another card]

- Access to the card has failed.
→ Insert the card again.
- Try with a different card.

[Memory card parameter error]

- The card is not of SD standard.
- With capacities of 4 GB or more, only SDHC or SDXC Memory Cards are supported.

[Read Error] / [Write Error] [Please check the card]

- Reading the data has failed.
→ Check whether the card has been inserted correctly (→19).
- Writing the data has failed.
→ Turn off the power and remove the card, before re-inserting and turning on the power again.
- The card may possibly be damaged.
- Try with a different card.

[Cannot record due to incompatible format(NTSC/PAL) data on this card.]

- Format the card after saving necessary data on a PC etc. (→60)
- Insert a different card.

[Motion recording was cancelled due to the limitation of the writing speed of the card]

- If recording stops even when using a card of the recommended speed class (→20), the data writing speed has dropped. If this happens, we recommend backing up the data on the memory card and formatting it (→60).
- Motion picture recording may be automatically terminated with certain cards.

[A folder cannot be created]

- The folder numbers in use have reached 999.
→ Save the needed data on a computer or an other device, and then use [Format] on the camera.
(→60)Folder number is reset to 100 when performing [No.Reset] (→58).

[Picture is displayed for 16:9 TV] [Picture is displayed for 4:3 TV]

- The camera is connected through the supplied AV cable.
→ To remove a message immediately → Press [MENU/SET].
→ To change an aspect ratio → Change [TV Aspect] (→59).
- The USB connection cable (supplied) is only connected to camera.
→ The message disappears when the cable is also connected to another device.

[This battery cannot be used]

- Use a genuine Leica battery.
- The battery cannot be recognized as its terminals are dirty.
→ Wipe any dirt away from the battery terminal.

[GPS feature is not available in this region.]

- GPS may not work in China or in the border regions of countries neighboring China. (Current as of December 2011)

[Recording failed.]

- Recording may be impossible if the recording location for a 3D image is too dark/too bright, or if the subject lacks contrast.

Q&A Troubleshooting

Try checking these items (→176 - 183) first.

If the problem persists, performing [Reset] in the [Setup] menu may resolve the issue (→58). (Note that except for some items such as [Clock Set], all settings are returned to their values at the time of purchase.)

Battery, power

The charging lamp turns off before the battery is fully charged.

- Charging is being performed in a place with an extremely high or low temperature.
→ Reconnect the USB connection cable (supplied) and retry charging in a place where the ambient temperature is 10°C to 30°C (50°F to 86°F) (temperature conditions also apply to the battery itself).
(When the USB connection cable is reconnected after the battery is fully charged, the charging lamp will light for approximately 15 seconds.)

The charging lamp turns on again after it had turned off.

- The battery is being recharged.
→ If the battery charge level is low when the camera is turned off and [GPS Setting] is set to [ON], battery recharging may be started automatically.

The camera does not work even if the power is turned on.

- The battery is not inserted correctly (→14), or needs recharging.

The monitor is switched off even if power is turned on.

The camera switches off as soon as the power is turned on.

- [Sleep Mode] is activated. (→57)
→ Press the shutter release button halfway to release.
- The battery needs recharging.

The camera is switched off automatically.

- If you connect to a TV compatible with HDTV Link (HDMI) with the HDMI mini cable (available as accessory →9) and turn off the power on the TV with the remote control for the TV, the camera is also switched off.
→ If you are not using HDTV Link (HDMI), set [HDTV Link] to [OFF]. (→59)

GPS

Positioning is not performed.

- When [GPS Setting] is set to [OFF]. (→128)
- Depending on the recording environment, such as when indoors or near buildings, it may not be possible to correctly receive the signals from the GPS satellites. (→127)
→ When using the GPS, we recommend holding the camera still for a while with the built-in GPS antenna facing upward in an outdoor location where you can see the entire sky.

The GPS status indicator lights up while the camera's power is off.



- [GPS Setting] is [ON].
→ Electromagnetic radiation from the camera can affect instruments and meters. During takeoff and landing of airplanes or in other restricted areas, set [GPS Setting] to [OFF] or set [Airplane Mode] to [ON], and then turn off the camera.

GPS (continued)

Positioning takes time.

- When using the camera for the first time or after not using it for a while, positioning may take several minutes.
- Positioning usually takes less than two minutes, but because the positions of the GPS satellites change, it may take longer depending on the recording location and environment.
→ Positioning can be executed faster when you download GPS assist data to the camera using the "GPS Assist Tool". (→140)
- Positioning will take time in environments where it is difficult to receive the signals from the GPS satellites. (→127)

The location name information is different from the recording location.

- Immediately after the camera's power is turned on or when the GPS icon is something other than , the location name information that is recorded in the camera may vary significantly from the current position.
- When  is displayed for the location name information, the information can be changed to a different candidate before starting to record. (→135)
- You can edit a place name or landmark name recorded in a picture.

The location name information is not displayed.

- "- -" is displayed if there is no nearby landmark or other points, or no information registered in the camera's database. (→130)
→ During playback, a location name or other information can be entered with [Edit Place Name]. (→138)

Map

The detailed maps are not displayed.

- Use the "LEICA Map Tool" software on the DVD (supplied) to copy map data from the DVD. (→149)

Some place names are not displayed.

- Detailed maps are displayed when you copy map data from the DVD (supplied). (→149)
(Note, however, that not all place names are stored in the DVD.)
- Place names may not be displayed for some map scale settings.
→ Enlarge the map scale.

It takes time to copy the map data.

- Since the map data size is large, it may take time to copy the map data. We recommend copying the map data of a required area only.
- When you copy map data by connecting the camera to the computer, it may take longer than the time required for copying the data using the commercially available card reader/writer.

Recording

Pictures are not recorded.

- The REC/PLAY switch is not set to  (record).
- The built-in memory/card is full. → Create memory capacity by deleting unwanted pictures (→49).

The recorded pictures look clouded.

- The lens is dirty (fingerprints, etc.).
→ Turn on the power to extend lens barrel, and clean the lens surface with a soft, dry cloth.
- The lens is fogged (→6).

The recorded pictures are too bright/too dark.

- Adjust the exposure (→71).
- [Min. Shtr Speed] is set to a fast speed. Check the setting (→102).

Recording (continued)

Several pictures are taken when I press the shutter release button just once.

- The camera is set to use [Auto Bracket] or [Burst].

The focus setting is not correct.

- The mode set is not appropriate for the distance to the subject. (The focus range varies according to recording mode.)
- The subject is outside of the focus range. (→68)
- This may be caused by camera shake or subject movement. (→27)

The recorded pictures are blurred. The optical Image Stabilizer is ineffective.

- The shutter speed is slower in dark locations and the Optical Image Stabilizer is less effective.
→ Hold the camera firmly with both hands, keeping your arms close to your body.
- Use a tripod and the self-timer (→70) when using slower shutter speed with [Min. Shtr Speed].

[Auto Bracket] cannot be used.

- The remaining memory capacity is only enough for 2 pictures or fewer.

The recorded pictures appear coarse, or there is interference.

- The ISO Sensitivity is high, or the shutter speed is low.
(Default [Sensitivity] setting is [AUTO] – interference may appear with indoor pictures.)
→ Reduce the [Sensitivity] (→96).
→ Take the pictures in brighter locations.
- The camera is set to [High Sens.] Scene mode.
(The picture becomes slightly coarser in response to high sensitivity)

Striping or flicker may appear under lighting such as fluorescent and LED lighting.

- This is a characteristic of MOS sensors like the one in this camera. This is not a malfunction.

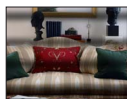

The brightness and the color of a recorded picture differ from reality.

- When recording under fluorescent or LED lighting etc., increasing the shutter speed may introduce slight changes to brightness and color. These are a result of the characteristics of the light source and do not indicate a malfunction.
- When recording subjects in extremely bright locations or recording under fluorescent lighting, LED lighting, mercury lamps, sodium lighting etc., the colors and screen brightness may change or horizontal striping may appear on the screen.

Reddish horizontal streaks appear on the monitor during recording.

- This is characteristic of MOS sensors like the one in this camera. It appears when the subject has a bright part. Some unevenness may occur in the surrounding areas, but this is not a malfunction. It is recorded in motion pictures but not in still pictures.
- It is recommended that you take pictures while taking care not to expose the screen to sunlight or any other source of strong light.

Recording (continued)

Motion picture recording stops midway.

- **With camera models 18 176 / 18 177**

If [Rec Quality] of [AVCHD] motion pictures is set to [GPH], [PSH], [GFS] or [FSH], you can continuously record a motion picture for up to 29 minutes. (→107)

You can continuously record a motion picture in [MP4] for up to 29 minutes or approx. 4 GB.

(In this case, you can continuously record a motion picture in [FHD] for up to approx. 27 minutes 12 seconds.)

- **With camera model 18 175**

Motion pictures can be recorded continuously for up to 29 minutes. Also, motion picture recorded continuously in [MP4] is up to 4 GB. (In this case, you can continuously record a motion picture in [FHD] for up to approx. 27 minutes 12 seconds.)

- If the surrounding temperature is high, or a motion picture is recorded continuously,  is displayed and recording may be stopped halfway through to protect the camera. (Only when [Rec Quality] is set to [GPH], [PSH], [GFS] or [FSH])
- With some cards, the access display may appear briefly after recording, and recording may end midway.
- If recording stops even when using a card of the recommended speed class (→20), the data writing speed has dropped. If this happens, we recommend backing up the data on the memory card and formatting it (→60).

Panorama picture recording stops before finishing.

- If the pan motion of the camera is too slow, the camera assumes that the operation has been aborted and stops recording.
- If the pan motion of the camera is too shaky when it is moved in the recording direction, the camera stops recording.
→ To record panorama pictures, pan the camera in a small circular motion parallel to the recording direction at a speed of approx. 8 seconds per revolution (guideline).

The subject cannot be locked. (AF tracking fails)

- If the color of the subject is similar to that of its background, AF Tracking may not function. Set the AF area to those colors specific to the subject by aiming the AF frame at that area.

Monitor

The display brightness changes.

- The aperture value is set while the shutter release button is pressed halfway. (This does not affect recorded picture.)
This symptom may also occur when the brightness changes because the zoom is operated or the camera is moved. This is the automatic aperture operation of the camera and is not a malfunction.

The monitor image flickers indoors.

- The monitor may flicker for a few seconds after turning it on. This is an operation to correct flicker caused by lighting such as fluorescent lights, LED lights etc. and is not a malfunction.

The monitor image is too bright/too dark.



- [LCD Mode] is activated (→55)
- Use [LCD Display] to adjust the brightness of the monitor. (→55)

Black/blue/red/green dots or interference appears. The monitor image looks distorted when touched.

- This is not a fault, and will not be recorded on the actual pictures.

Flash

No flash is emitted.

- The flash is set to  [Forced Flash Off] (→66).
- The flash becomes unavailable in the following cases :
 - [Auto Bracket]
 - [Burst] (However, when  [Flash Burst] is selected, the flash is fixed to  [Forced Flash On].)
 - Scene Modes ([Scenery] [Panorama Shot] [Night Scenery] [Handheld Night Shot] [HDR] [Sunset] [Through window] [High Speed Video])
 - [3D Photo Mode]
 - [Creative Control] Mode

Multiple flashes are emitted.

- Red-eye reduction is active (→66). (Flashes twice to prevent eyes appearing red.)
- [Burst] is set to [Flash Burst] (→87).

Playback

Pictures have been rotated.

- [Rotate Disp.] is activated (→60)

Pictures cannot be viewed. There are no recorded pictures.

- The REC/PLAY switch is not set to  (play).
- There are no pictures in the built-in memory or on the card (pictures played from the card if one is inserted, from the built-in memory if not).
- Has the file name of the picture been changed on a computer? If so, it cannot be played back on the camera.
- The [Playback Mode] has been changed.
→ Set [Playback Mode] to [Normal Play] (→111).

The folder/file number is displayed as [-]. The picture is black.

- The picture has been edited on a computer or a taken with a different device.
- The battery had been removed immediately after the picture was taken, or the picture was taken with a low battery.
→ Use [Format] to delete (→60).

An incorrect date is displayed in Calendar Playback.

- The picture has been edited on a computer or taken with a different device.
- [Clock Set] is incorrect (→23).
(An incorrect date may be displayed in Calendar Playback on pictures copied to a computer and then back to the camera, if the computer and camera dates differ.)

White round spots like soap bubbles appear on the recorded picture.

- If you take a picture with the flash in a dark place or indoors, white round spots may appear on the picture caused by particles such as dust in the air reflecting the light from the flash. This is not a fault. A characteristic of this is that the number of round spots and their position differ in every picture.



[Thumbnail is displayed] is shown on the screen.

- The pictures may have been recorded on another device. If so, they may be displayed with poor picture quality.

Playback (continued)

Red parts are rendered black in the recorded pictures.

- When digital red-eye correction (👁️👁️, 👁️👁️) is operating, if a subject is recorded that has skin-colored areas with red areas inside, the digital red-eye correction function may blacken the red areas.
→ We recommend setting the flash to 📷, 📷 or 📷, or [Red-Eye Removal] to [OFF] before recording.

Sounds of camera operations such as zooming are recorded in motion pictures.

- Camera operation sounds may be recorded when the camera automatically adjusts the lens aperture during motion picture recording; this is not a fault.

Motion pictures taken by this camera cannot be played back with other cameras.

- When motion pictures recorded in [AVCHD], [MP4] or [High Speed Video] (Motion JPEG) are played back, they may be displayed with poor picture quality or sound quality or may not be played back at all even if an AVCHD, MP4 or Motion JPEG compatible device is used. Also, there might be a case that a recording information does not display correctly.

TV, computer, printer

No image appears on TV. The image is blurred or not colored.

- The devices are not connected correctly (→155).
- The television has not been switched to auxiliary input.
- Check the [Video Out] setting (NTSC/PAL) on the camera. (→59) (With camera model 18 175)

The display on the TV is different than that on the monitor.

- The aspect ratio may be incorrect, or the edges may be cut off with certain televisions.

Cannot play motion pictures on TV.

- The card is inserted into the TV.
→ Connect with the AV cable (included in scope of delivery) or the HDMI mini cable (available as accessory →9) and play on camera (→155).

The picture is not displayed on the complete TV screen.

- Check the [TV Aspect] settings (→59).

HDTV Link (HDMI) does not work.

- Is the HDMI mini cable (available as accessory →9) connected correctly? (→155)
→ Check that the it is fully inserted.
- Is the camera's [HDTV Link] setting set to [ON]? (→59)
→ The input setting may not be able to be changed automatically with certain television HDMI sockets. In this case, please change the input setting with your television's remote control (consult your television's instructions for details).
→ Check the HDTV Link (HDMI) settings on the device you are connecting to.
→ Turn the camera's power off and on again.
→ Turn the "HDTV Link control (HDMI device control)" setting on your television to off and then to on again. (Consult your TV's instructions for details.)

Pictures cannot be sent to a computer.

- The connection is not correct (→164).
- Check whether the computer has recognized the camera.
→ Set [USB Mode] to [PC] (→58).
→ Switch the camera off and then back on again.

TV, computer, printer (continued)**The computer does not recognize the card (it only reads the built-in memory).**

- Disconnect the USB connection cable (supplied) and reconnect with a card in place.

The computer does not recognize the card. (When using SDXC Memory Cards)

- Check whether your computer is compatible with SDXC Memory Cards.
- A message prompting you to format the card may appear when you connect it. Do not format the card.
- If the [Access] indicator on the monitor does not go off, switch off the camera before disconnecting the USB connection cable.

Printing is not possible when connected to a printer.

- The printer is not compatible with PictBridge.
- Set [USB Mode] to [PictBridge(PTP)] (→58).

The edges of pictures are cut off when printing.

- Cancel any trimming or edgeless printing settings on the printer before printing. (Consult the printer's instructions.)
- The pictures were recorded in **16:9** aspect ratio.
 - If you are having your pictures printed in a shop, check if 16:9 sizes can be printed.

Printing panorama pictures does not succeed.

- The aspect ratio of panorama pictures is different from that of regular still pictures, and some panorama pictures may not be printed correctly.
 - Use a printer with support for panorama pictures. (Refer to the instructions for the printer.)

Others**The menu is not displayed in the desired language.**

- Change the [Language] setting (→61).

The camera rattles if shaken.

- This sound is made by the lens movement and is not a fault.

The red lamp is illuminated when pressing the shutter release button halfway in dark locations.

- [AF Assist Lamp] is set to [ON] (→103).

The AF Assist Lamp is not illuminated.

- [AF Assist Lamp] is set to [OFF] (→103).
- The lamp is not switched on in bright locations.

The camera is hot.

- The camera may become a little warm during use, but this does not affect performance or quality.

The lens makes a clicking noise.

- When the brightness changes, the lens may make a clicking noise and the monitor brightness may also change, but this is due to aperture settings being made.
(This does not affect recording.)

The displayed time is incorrect.

- The camera has not been used for a long time.
→ Reset the clock (→24).
- A long time was taken to set the clock (clock will be behind by the same lapse of time).

Zooming stops momentarily.

- The zoom movement stops momentarily during Extra Optical Zoom operation, but this is not a malfunction.

The lens does not allow setting the longest focal length/the maximum zoom ratio.

- If the zoom ratio stops at 3 x, [Macro Zoom] has been set. (→69)

The file numbers are not recorded in sequence.

- File numbers are reset when new folders are created (→165).

The file numbers have jumped backwards.

- The battery was removed/inserted with power on.
(Numbers may jump backwards if the folder/file numbers are not correctly recorded.)

Usage cautions and notes

When in use

- The camera may become warm if used for long periods of time, but this is not a fault.
- **Keep the camera as far away as possible from electromagnetic equipment (such as microwave ovens, TVs, video games etc.).**
 - If you use the camera on top of or near a TV, the pictures and/or sound may be disrupted by electromagnetic radiation.
 - Do not use the camera near cell phones because doing so may result in noise adversely affecting the pictures and/or sound.
 - Recorded data may be damaged, or pictures may be distorted, by strong magnetic fields created by speakers or large motors.
 - Electromagnetic radiation generated by microprocessors may adversely affect the camera, disturbing the pictures and/or sound.
 - If the camera is adversely affected by electromagnetic equipment and stops functioning properly, turn it off and remove the battery or disconnect the charger. Then reinsert the battery or reconnect the charger and turn the camera on.

Do not use the camera near radio transmitters or high-voltage lines.

- If you record near radio transmitters or high-voltage lines, the recorded pictures and/or sound may be adversely affected.
- Do not extend the supplied cord or cable.
- Do not allow the camera to come into contact with pesticides or volatile substances (they can cause surface damage or the coating to peel).
- Never leave the camera and the battery in a car or on a car hood in the summer. It may cause leakage of the battery electrolyte, a generation of heat, and may cause a fire and the battery to explode due to the high temperature.

Caring for your camera

To clean your camera, remove the battery or disconnect the power plug from the outlet, and wipe with a soft, dry cloth.

- Use a damp cloth to remove stubborn stains, before wiping with a dry cloth.
- Do not use benzine, thinners, alcohol, or kitchen detergent, as these may damage the outer casing and finish of the camera.
- If using a chemically-treated cloth, read the supplied instructions carefully.
- Do not obstruct the lens barrel's movement.

When not using for a while

- Switch off the camera before removing the battery and the card (ensure that the battery is removed to prevent damage through over-discharge).
- Do not leave the camera in contact with rubber or plastic bags.
- Store the camera together with a drying agent (silica gel) if leaving in drawer, etc. Store batteries in cool (15°C to 25°C (59°F to 77°F)) places with low humidity (40%RH to 60%RH) and no major temperature changes.
- Charge the battery once per year and deplete it completely before storing again.

Memory cards

- To prevent damage to cards and data
 - Avoid high temperatures, direct sunlight, electromagnetic radiation, and static electricity.
 - Do not bend, drop, or expose to strong impacts.
 - Do not touch terminals on reverse of card or allow them to become dirty or wet.
- When disposing of/transferring memory cards
 - Using the "format" or "delete" functions on your camera or computer only changes the file management information, and does not completely delete the data on the memory card. When disposing of or transferring your memory cards, we recommend physically destroying the memory card itself, or using commercially available computer data erasing software to completely delete the data from the card. Data within memory cards should be managed responsibly.

Monitor

- Do not exert excessive force on the monitor surface. This may cause an uneven display and damage it.
- In cold climates or other situations when the camera becomes cold, the monitor may appear slightly darker than normal immediately after the camera is turned on. Normal brightness will return once the internal components have warmed up.

Extremely high precision technology is employed to produce the monitor. However some dark or bright spots (red, blue or green) may appear on the screen. This is not a malfunction. The monitor screen has more than 99.99% effective pixels with a mere 0.01% of the pixels inactive or always lit. The spots will not be recorded on pictures on the built-in memory or a card.

About charging the battery

- The time required for charging varies depending on conditions of battery usage. Charging takes longer at high or low temperatures and when the battery has not been used in some time.
- The battery will get warm during charging and for some time thereafter.
- The battery will run out if not used for long periods of time, even after being charged.
- Do not leave any metal items (such as clips) near the power plug terminals. Otherwise, a fire and/or electric shocks may be caused by short-circuiting or the resulting heat generated.
- Frequently charging the battery is not recommended. (This would reduce maximum usage time and can cause battery to expand.)
- If the available battery power is significantly reduced, it is reaching its end of lifespan. Please purchase a new battery.
- When charging:
 - Wipe dirt from the battery terminals with a dry cloth.
 - Keep at least 1 m (3.3 feet) away from an AM radio (otherwise, it might cause radio interference).
- Do not use a damaged or dented battery (especially the terminals), e.g. by dropping (this can cause faults).

About the charger (supplied)

- Keep it at least 1 m (3.3 feet) away from an AM radio (otherwise, it might cause radio interference).
- The charger may generate whirring sounds when it is being used. This is not a malfunction.
- After use, be sure to disconnect the connection to the electrical outlet. (A very small amount of current is consumed if it is left connected.)

Lens

- Images may appear slightly clouded if the lens is dirty (fingerprints, etc.). Turn the power on, hold the extracted lens barrel with your fingers, and gently wipe the lens surface with a soft, dry cloth.
- Do not leave the lens exposed to direct sunlight.
- Do not obstruct the movement of the lens barrel, as this may damage the lens. Be careful when removing the camera from a bag, etc.

When using a tripod or unipod

- Do not apply excessive force or damaged or bent screws. (This may damage the camera, the camera's tripod thread, or the label.)
- Ensure that the tripod is stable. (Refer to the tripod's instructions.)
- You may not be able to remove the card or the battery when using a tripod or unipod.

About 3D viewing

- Anyone who is hypersensitive to light, suffers from heart disease or is otherwise unwell should avoid viewing 3D contents.
 - Viewing 3D contents may have an adverse effect to the individual.
- If you feel tired, uncomfortable or otherwise strange when viewing 3D contents, stop viewing at once.
 - Continuing to view may cause illness.
 - After stopping viewing, please rest appropriately.
- When viewing 3D contents, we recommend taking a break every 30 to 60 minutes.
 - Viewing for extended periods may cause eye-fatigue.
- Short-sighted or long-sighted persons, those with differences in the sight of their right and left eyes, and those with astigmatism are advised to correct their vision by wearing glasses etc. Stop viewing if you can clearly see a double image while viewing 3D contents.
 - There are differences in the way that different people experience 3D contents. Please correct your sight appropriately before viewing 3D contents.
 - You can change the 3D setting of your television or 3D output setting of the unit to 2D.

Personal Information

If names or birthdays are set in [Baby] Mode or in the [Face Recog.] function, keep in mind that the camera and recorded pictures will contain personal information.

- Disclaimer
 - Data containing personal information can be altered or lost due to malfunction, static electricity, accidents, breakdowns, repairs, or other operations.
Leica Camera AG will not be liable for any damage that occurs, direct or indirect, as a result of the alteration or loss of data containing personal information.
- When ordering repairs or transferring/disposing of the camera
 - To protect your personal information, please reset the settings. (→58)
 - If any pictures are contained in the built-in memory, copy (→126) them to a memory card if necessary, and then format (→60) the built-in memory.
 - Remove the memory card from the camera.
 - When ordering repairs, the built-in memory and other settings may be returned to the initial purchase state.
 - If the above operations cannot be performed because of a camera malfunction, consult your Leica dealer or the nearest Leica Customer Care facility.

When transferring or disposing of your memory card, see “When disposing of/transferring memory cards” in the previous section (→185).

Important! Be sure to read the following before using the location names that are stored in this product.

Licence Agreement for Place Name and Map Data

Personal Use Only.

You agree to use this Data together with this digital camera for the solely personal, non-commercial purposes for which you were licensed, and not for service bureau, time-sharing or other similar purposes. Accordingly, but subject to the restrictions set forth in the following paragraphs, you agree not to otherwise reproduce, copy, modify, decompile, disassemble or reverse engineer any portion of this Data, and may not transfer or distribute it in any form, for any purpose, except to the extent permitted by mandatory laws. Multi-disc sets may only be transferred or sold as a complete set as provided by Leica Camera AG and not as a subset thereof.

Restrictions.

Except where you have been specifically licensed to do so by Leica Camera AG, and without limiting the preceding paragraph, you may not (a) use this Data with any products, systems, or applications installed or otherwise connected to or in communication with vehicles, capable of vehicle navigation, positioning, dispatch, real time route guidance, fleet management or similar applications; or (b) with or in communication with any positioning devices or any mobile or wireless-connected electronic or computer devices, including without limitation cellular phones, palmtop and handheld computers, pagers, and personal digital assistants or PDAs.

Warning.

The Data may contain inaccurate or incomplete information due to the passage of time, changing circumstances, sources used and the nature of collecting comprehensive geographic data, any of which may lead to incorrect results.

No Warranty.

This data is provided to you “as is,” and you agree to use it at your own risk. Leica Camera AG and its licensors (and their licensors and suppliers) make no guarantees, representations or warranties of any kind, express or implied, arising by law or otherwise, including but not limited to, content, quality, accuracy, completeness, effectiveness, reliability, fitness for a particular purpose, usefulness, use or results to be obtained from this data, or that the data or server will be uninterrupted or error-free.

Disclaimer of Warranty:

LEICA CAMERA AG AND ITS LICENSORS (INCLUDING THEIR LICENSORS AND SUPPLIERS) DISCLAIM ANY WARRANTIES, EXPRESS OR IMPLIED, OF QUALITY, PERFORMANCE, MERCHANTABILITY, FITNESS FOR A PARTICULAR PURPOSE OR NON-INFRINGEMENT. Some States, Territories and Countries do not allow certain warranty exclusions, so to that extent the above exclusion may not apply to you.

Disclaimer of Liability:

LEICA CAMERA AG AND ITS LICENSORS (INCLUDING THEIR LICENSORS AND SUPPLIERS) SHALL NOT BE LIABLE TO YOU: IN RESPECT OF ANY CLAIM, DEMAND OR ACTION, IRRESPECTIVE OF THE NATURE OF THE CAUSE OF THE CLAIM, DEMAND OR ACTION ALLEGING ANY LOSS, INJURY OR DAMAGES, DIRECT OR INDIRECT, WHICH MAY RESULT FROM THE USE OR POSSESSION OF THE INFORMATION; OR FOR ANY LOSS OF PROFIT, REVENUE, CONTRACTS OR SAVINGS, OR ANY OTHER DIRECT, INDIRECT, INCIDENTAL, SPECIAL OR CONSEQUENTIAL DAMAGES ARISING OUT OF YOUR USE OF OR INABILITY TO USE THIS INFORMATION, ANY DEFECT IN THE INFORMATION, OR THE BREACH OF THESE TERMS OR CONDITIONS, WHETHER IN AN ACTION IN CONTRACT OR TORT OR BASED ON A WARRANTY, EVEN IF LEICA CAMERA AG OR ITS LICENSORS HAVE BEEN ADVISED OF THE POSSIBILITY OF SUCH DAMAGES. Some States, Territories and Countries do not allow certain liability exclusions or damages limitations, so to that extent the above may not apply to you.

Export Control.

Leica Camera AG shall not export from anywhere any part of the Data or any direct product thereof except in compliance with, and with all licenses and approvals required under, applicable export laws, rules and regulations, including but not limited to the laws, rules and regulations administered by the Office of Foreign Assets Control of the U.S. Department of Commerce and the Bureau of Industry and Security of the U.S. Department of Commerce. To the extent that any such export laws, rules or regulations prohibit NT from complying with any of its obligations hereunder to deliver or distribute Data, such failure shall be excused and shall not constitute a breach of this Agreement.

Entire Agreement.

These terms and conditions constitute the entire agreement between Leica Camera AG (and its licensors, including their licensors and suppliers) and you pertaining to the subject matter hereof, and supersedes in their entirety any and all written or oral agreements previously existing between us with respect to such subject matter.

About Location Information, Place Name Information, and Maps

About the geographical coordinate system

The latitude and longitude standard (geographical coordinate system) recorded with this camera is WGS84.

Mapple Digital Map Data

These maps were prepared using the following maps of the Geospatial Information Authority of Japan (GSI), with the approval of the Director General of GSI: 1:25,000 scale topographic maps, 1:200,000 scale regional maps, 1:1,000,000 scale maps of Japan, and 1:500,000 scale district maps. (Approval nos. for use of 2011 information: nos. 15-, 13-, and 12-M055541)

About copyright

According to copyright law, the map data stored in this camera may not be used for purposes other than personal use without the permission of the copyright holder.

About navigation functions

This camera is not equipped with a navigation function.

Notices related to licensed software copyright holders



© 2011 NAVTEQ. All rights reserved.



MAPPLE

"MAPPLE" is a trademark of Shobunsha Publications, Inc.

This data includes information taken with permission from Canadian authorities, including © Her Majesty the Queen in Right of Canada, © Queen's Printer for Ontario, © Canada Post Corporation, GeoBase®, © Department of Natural Resources Canada. All rights reserved.

© United States Postal Service® 2011, USPS®, ZIP+4®

Fuente: INEGI (Instituto Nacional de Estadística y Geografía)

Traffic Codes for Belgium are provided by the Ministerie van de Vlaamse Gemeenschap and the Ministère de l'Équipement et des Transports.

Territory	Notice
Australia	© Hema Maps Pty. Ltd, 2011. Copyright. Based on data provided under license from PSMA Australia Limited (www.pasma.com.au). Product incorporates data which is © 2011 Telstra Corporation Limited, GM Holden Limited, Intelematics Australia Pty Ltd, NAVTEQ International LLC, Sentinel Content Pty Limited and Continental Pty Ltd.
Austria	"© Bundesamt für Eich- und Vermessungswesen"
Croatia, Cyprus, Estonia, Latvia, Lithuania, Moldova, Poland, Slovenia and/or Ukraine	"© EuroGeographics"
Ecuador	INSTITUTO GEOGRAFICO MILITAR DEL ECUADOR AUTORIZACION N° IGM-2011-01- PCO-01 DEL 25 DE ENERO DE 2011
France	The following notice must appear on all copies of the Data, and may also appear on packaging: "source: © IGN France – BD TOPO ®"
Germany	"Die Grundlagendaten wurden mit Genehmigung der zuständigen Behörden entnommen" or "Die Grundlagendaten wurden mit Genehmigung der zustaendigen Behoerden entnommen."
Great Britain	"Contains Ordnance Survey data © Crown copyright and database right 2010 Contains Royal Mail data © Royal Mail copyright and database right 2010"
Greece	"Copyright Geomatics Ltd."
Guadeloupe, French Guiana Martinique	"source: © IGN 2009 - BD TOPO ®"
Guatemala	"Aprobado por el INSTITUTO GEOGRAFICO NACIONAL – Resolución del IGN N° 186-2011"
Hungary	"Copyright © 2003; Top-Map Ltd."
Israel	"© Survey of Israel data source"
Italy	"La Banca Dati Italiana è stata prodotta usando quale riferimento anche cartografia numerica ed al tratto prodotta e fornita dalla Regione Toscana."
Jordan	"© Royal Jordanian Geographic Centre". The foregoing notice requirement for Jordan Data is a material term of the Agreement. If Client or any of its permitted sublicensees (if any) fail to meet such requirement, NT shall have the right to terminate Client's license with respect to the Jordan Data.
Mozambique	"Certain Data for Mozambique provided by Cenacarta © 2011 by Cenacarta"
Norway	"Copyright © 2000; Norwegian Mapping Authority"
Portugal	"Source: IgeoE – Portugal"
Réunion	"source: © IGN 2009 - BD TOPO ®"
Spain	"Información geográfica propiedad del CNIG"
Nepal	Copyright © Survey Department, Government of Nepal.

Usage cautions and notes

Territory	Notice
Sri Lanka	This product incorporates original source digital data obtained from the Survey Department of Sri Lanka © 2009 Survey Department of Sri Lanka The data has been used with the permission of the Survey Department of Sri Lanka
Sweden	"Based upon electronic data © National Land Survey Sweden."
Switzerland	"Topografische Grundlage: © Bundesamt für Landestopographie."

■ Landmark types

Although approx. 1,000,000 landmarks are registered in the built-in memory, there are also some unregistered landmarks. (The registered information is current as of December 2011 and will not be updated.)

- It differs from that registered on our GPS-equipped models before 2011.

Zoo	Botanical garden	Aquarium
Amusement park	Golf course	Camp sites
Ski resorts	Skating rinks	Outdoor activity sites
Famous site, tourist attraction, beauty spot	Castle, ruins	Shrine
Temple	Church	Tomb, monument, mound, historic site
Airport	Port	Ferry terminal
Baseball park	Athletics ground	Gymnasium
Park	Station	Prefectural or state office
Lifts, cable cars	Art museum	History museum
Theatre	Cinemas, performing theatres	Wineries, breweries
Mountains, meadows, passes	Canyons, mountain streams, waterfalls, valleys, seashores	Tower, high-rise building

Leica service addresses

Leica Academy

As well as outstanding high-performance products for taking and viewing photographs, for many years we have also been offering the special services of the Leica Akademie, with practical seminars and training courses, which are intended to share our knowledge about the world of photography, projection and magnification with both beginners and advanced photo graphic enthusiasts.

The contents of the courses, which are run by a trained team of experts in the modern, well-equipped training suite at our Solms factory and in the nearby Gut Altenberg, vary from general photography to areas of special interest and offer a range of suggestions, information and advice for your own work.

More detailed information and the current Leica Academy brochure are available from:

Leica Camera AG
Leica Akademie
Oskar-Barnack-Str. 11
D-35606 Solms
Phone: +49 (0) 6442-208-421
Fax: +49 (0) 6442-208-425
la@leica-camera.com

Leica on the Internet

Current information about products, news, events and the Leica company is available on our homepage on the Internet at:

<http://www.leica-camera.us>
<http://www.leica-camera.co.uk>

Leica Information Service

Should you have any technical questions regarding the use of Leica products or the software included in some cases, Leica information service will be happy to answer in writing or by phone, fax, or e-mail.

They are also your contact if you need advice concerning an acquisition or if you would like us to send you instructions.

Alternatively, you can also send us your questions through the contact form on the Leica Camera AG homepage (see above).

Leica Camera AG

Information-Service / Software-Support

Postfach 1180

D-35599 Solms

Phone: +49 (0) 6442-208-111 / -108

Fax: +49 (0) 6442-208-490

info@leica-camera.com / software-support@leica-camera.com

Leica Customer Care

Leica Camera AG's Customer Care center, or the repair service of the Leica national offices (see the Warranty Card for an address list), is available to assist you in maintaining your Leica equipment or in case of damage.

Please contact your nearest authorised Leica dealer.

Leica Camera AG

Customer Care

Solmser Gewerbepark 8

D-35606 Solms

Phone: +49 (0) 6442-208-189

Fax: +49 (0) 6442-208-339

customer.care@leica-camera.com

HDMI

AVCHD™
Progressive

DOLBY
DIGITAL
STEREO CREATOR

SD™
XC



3D



- HDMI, the HDMI Logo, and High-Definition Multimedia Interface are trademarks or registered trademarks of HDMI Licensing LLC in the United States and other countries.
- “AVCHD Progressive”, “AVCHD”, the “AVCHD Progressive” Logo and the “AVCHD” Logo are trademarks of Panasonic Corporation and Sony Corporation.
- Manufactured under license from Dolby Laboratories. Dolby and the double-D symbol are trademarks of Dolby Laboratories.
- SDXC Logo is a trademark of SD-3C, LLC.
- QuickTime and the QuickTime logo are trademarks or registered trademarks of Apple Inc., used under license therefrom.
- Windows and Windows Vista are either registered trademarks or trademarks of Microsoft Corporation in the United States and/or other countries.
- iMovie, Mac and Mac OS are trademarks of Apple Inc., registered in the U.S. and other countries.
- This product uses “DynaFont” from DynaComware Corporation. DynaFont is a registered trademark of DynaComware Taiwan Inc.
- Leica is a registered trademark of Leica Microsystems IR GmbH.
- Elmar is a registered trademark of Leica Camera AG.
- Adobe Photoshop Elements and Adobe Premiere Elements are registered trademarks of Adobe Systems Incorporated.
- Other names, company names, and product names printed in these instructions are trademarks or registered trademarks of the companies concerned.

This product is licensed under the AVC patent portfolio license for the personal and non-commercial use of a consumer to (i) encode video in compliance with the AVC Standard (“AVC Video”) and/or (ii) decode AVC Video that was encoded by a consumer engaged in a personal and non-commercial activity and/or was obtained from a video provider licensed to provide AVC Video. No license is granted or shall be implied for any other use. Additional information may be obtained from MPEG LA, LLC.
See <http://www.mpegla.com>.



my point of view

Leica Camera AG / Oskar-Barnack-Straße 11 /
D-35606 SOLMS / DEUTSCHLAND
Telefon +49 (0) 6442-208-0 / Telefax +49 (0) 6442-208-333
www.leica-camera.com